

TravelMate 220/260 Service Guide

Service guide files and updates are available
on the CSD web; for more information,
please refer to <http://csd.acer.com.tw>



100% Recycled Paper

Revision History

Please refer to the table below for the updates made on Travelmate 220/260 service guide.

Date	Chapter	Updates
01/03/2002	Chapter 1	Revised CPU Type from Celeron 933 to celeron 1.06 GHz with 256KB cache
		Revised Super I/O Controller to Mitsubishi 38859F
		Revised CPU package to PIII 1 GHz uFCBGA2 and to Celeron 1.06 GHz UFBGA2
		Revised BIOS version to AOEO
		Delete IBM(IC25N030ATD) Specifications for HDD Interface
		Changed TEAC to Mitsubishi and its specifications in CD-ROM interface.
	Chapter 5	Revised PCB N0. to 01213-1
	Appendix A	Revision: "Note" was deleted.
	Appendix B	Remove ELPIDA 128 and 256MB for memory specifications
		Remove TEAC for DVD-ROM specifications.
		Add (DVD + CD-RW) for Combo driver.
Remove Simplo Ni-MH, Sanyo Li-ION, Sanyo Ni-MH specifications for battery.		
Remove US 2 pin for Power Code:		
01/18/2002	Chapter 1	Change DVD-RW to DVD/CD-R/CD-RW and modify battery specs.
		.

Copyright

Copyright © 2001 by Acer Incorporated. All rights reserved. No part of this publication may be reproduced, transmitted, transcribed, stored in a retrieval system, or translated into any language or computer language, in any form or by any means, electronic, mechanical, magnetic, optical, chemical, manual or otherwise, without the prior written permission of Acer Incorporated.

Disclaimer

The information in this guide is subject to change without notice.

Acer Incorporated makes no representations or warranties, either expressed or implied, with respect to the contents hereof and specifically disclaims any warranties of merchantability or fitness for any particular purpose. Any Acer Incorporated software described in this manual is sold or licensed "as is". Should the programs prove defective following their purchase, the buyer (and not Acer Incorporated, its distributor, or its dealer) assumes the entire cost of all necessary servicing, repair, and any incidental or consequential damages resulting from any defect in the software.

Acer is a registered trademark of Acer Corporation.

Intel is a registered trademark of Intel Corporation.

Pentium and Pentium II/III are trademarks of Intel Corporation.

Other brand and product names are trademarks and/or registered trademarks of their respective holders.

Conventions

The following conventions are used in this manual:

Screen messages	Denotes actual messages that appear on screen.
NOTE	Gives bits and pieces of additional information related to the current topic.
WARNING	Alerts you to any damage that might result from doing or not doing specific actions.
CAUTION	Gives precautionary measures to avoid possible hardware or software problems.
IMPORTANT	Reminds you to do specific actions relevant to the accomplishment of procedures.

Preface

Before using this information and the product it supports, please read the following general information.

1. This Service Guide provides you with all technical information relating to the BASIC CONFIGURATION decided for Acer's "global" product offering. To better fit local market requirements and enhance product competitiveness, your regional office MAY have decided to extend the functionality of a machine (e.g. add-on card, modem, or extra memory capability). These LOCALIZED FEATURES will NOT be covered in this generic service guide. In such cases, please contact your regional offices or the responsible personnel/channel to provide you with further technical details.
2. Please note WHEN ORDERING FRU PARTS, that you should check the most up-to-date information available on your regional web or channel. If, for whatever reason, a part number change is made, it will not be noted in the printed Service Guide. For ACER-AUTHORIZED SERVICE PROVIDERS, your Acer office may have a DIFFERENT part number code to those given in the FRU list of this printed Service Guide. You MUST use the list provided by your regional Acer office to order FRU parts for repair and service of customer machines.

Chapter 1	System Introduction	1
	Features	1
	System Block Diagram	3
	Board Layout	4
	Top View	4
	Bottom View	5
	Panel	6
	Front Panel	6
	Left Panel	7
	Right Panel	8
	Rear Panel	8
	Bottom Panel	9
	Indicators	10
	Keyboard	11
	Special keys	11
	Hot Keys	13
	Touchpad	15
	Touchpad basics	15
	Hardware Specifications and Configurations	17
Chapter 2	System Utilities	30
	BIOS Setup Utility	30
	Multi-Boot Menu	31
	Navigating the BIOS Utility	31
	System Information	32
	Basic System Settings	33
	Startup Configuration	33
	Onboard Device Configuration	35
	System Security	36
	Load Default Settings	39
	BIOS Flash Utility	40
	System Utility Diskette	40
	System Diagnostic Diskette	40
	Running PQA Diagnostics Program	41
Chapter 3	Machine Disassembly and Replacement	44
	General Information	45
	Before You Begin	45
	Disassembly Procedure Flowchart	46
	Removing the Battery Pack	49
	Removing the Battery Cover	49
	Removing the CD-ROM Drive Module	50
	Disassembling the CD-ROM Drive Module	50
	Removing the Hard Disk Drive Module	52
	Disassembling the Hard Disk Drive Module	52
	Removing the Extended Memory	54
	Removing the Modem Board	55
	Disassembling the LCD	56
	Removing the Hinge Caps	56
	Removing the Middle Cover	56
	Removing the Launch Board	56
	Removing the Cable Cover	57
	Removing the Keyboard	57
	Removing the LCD Module	58

Table of Contents

Removing the Video Capture Kit Covers	59
Removing the 14.1" TFT LCD Bezel	59
Removing the 13.3" TFT LCD Bezel	60
Removing the Speakers (14.1" TFT LCD)	61
Removing the Speakers (13.3" TFT LCD)	61
Removing the Inverter Board	62
Removing the 14.1" TFT LCD	63
Removing the 13.3" TFT LCD	64
Removing the 13.3" TFT LCD Brackets	64
Removing the LCD Coaxial Cable	65
Removing the Microphone Cable	66
Disassembling the Main Unit	67
Removing the CPU Heat Sink Plate	67
Removing the RTC Battery	67
Removing the Touch Pad Frame	67
Removing the Touch Pad Cable	68
Removing the Upper Case	69
Removing the RTC Battery Holder	70
Removing the Floppy Disk Drive Module	70
Disassembling the Floppy Disk Drive Module	71
Removing the Charger Plate	72
Removing the CPU Heat Sink	72
Removing the CPU Fan	73
Removing the Audio Board	73
Removing the Main Board	74
Removing the PCMCIA Slot	75
Removing the I/O Port Bracket	76
Removing the Modem Cable	77
Chapter 4 Troubleshooting	78
System Check Procedures	79
External Diskette Drive Check	79
External CD-ROM Drive Check	79
Keyboard or Auxiliary Input Device Check	80
Memory Check	80
Power System Check	80
Touchpad Check	82
Power-On Self-Test (POST) Error Message	83
Index of Error Messages	84
Index of Symptom-to-FRU Error Message	87
Intermittent Problems	90
Undetermined Problems	91
Index of AFlash BIOS Error Message	92
Index of PQA Diagnostic Error Code, Message	93
Chapter 5 Jumper and Connector Locations	94
Top View	94
Bottom View	96
Chapter 6 FRU (Field Replaceable Unit) List	98
Exploded Diagram	99

Table of Contents

Appendix A	Model Definition and Configuration	110
Appendix B	Test Compatible Components	112
	Microsoft Windows XP Home Edition Environment Test	113
Appendix C	Online Support Information	114
Index		116

System Introduction

Features

This computer was designed with the user in mind. Here are just a few of its many features:

Performance

- Intel® Mobile Pentium® III with 512KB cache or Celeron® CPU 1.06 GHz processor with 256KB cache
- 64-bit memory bus
- AcerMedia bay (removable CD-ROM, DVD-ROM, CD-RW or DVD/CD-R/RW drive)
- Built-in floppy drive
- High-capacity, Enhanced-IDE hard disk
- Power management system with ACPI (Advanced Configuration Power Interface)

Multimedia

- 16-bit high-fidelity AC'97 stereo audio with 3D sound and wavetable synthesizer
- Built-in dual speakers with microphone
- High-speed CD-ROM, DVD-ROM, CD-RW, or DVD/CD-R/RW, and drive (AcerMedia Bay)
- USB video capture kit option

Connectivity

- PS/2 interface, which also can be configured as keyboard/keypad interface.
- 85/88 key keyboard, which is IBM PC/AT keyboard compatible.
- Two Universal Serial Bus (USB) Ports
- CD-ROM/DVD-ROM/DVD/CD-R/RW Swappable Module
- RJ-11 for 56Kbps fax/modem
- Upgradeable memory and hard disk
- ECP/EPP Compliant parallel port.
- RS-232 (16550 compatible) serial port

Human-centric Design and Ergonomics

- All-in-one design (CD-ROM, floppy disk drive, hard disk drive)
- Sleek, smooth and stylish design
- Full-sized keyboard
- Ergonomically centred touchpad pointing device

Expansion

- One Type III or one Type II CardBus PC card (formerly PCMCIA) slot with ZV (zoomed video) support
- Upgradeable memory and hard disk

Display

- 13.3" or 14.1" TFT LCD displaying 32-bit true-color at 1024x768 XGA resolution
- 3D capabilities
- Supports other output display devices such as LCD projection panels for large audience presentations
- "Automatic LCD dim" feature that automatically decides the best settings for your display and conserves power.
- Simultaneous LCD and CRT display support
- Dual display capacity

Video performance

2X AGP video graphic accelerator with 8MB shared from system memory to boost video performance.

Simultaneous display

The computer's large display and multimedia capabilities are great for giving presentations. If you prefer, you can also connect an external monitor when giving presentations. This computer has built-in AGP and VGA display system to support simultaneous LCD and CRT display. Simultaneous display allows you to control the presentation from your computer and at the same time face your audience. You can also connect other output display devices such as LCD projection panels for large-audience presentations.

Dual Display

The computer's unique graphics chip takes advantage of Windows ME's multi-display capability, allowing you to extend your desktop to an external display device, such as an external monitor projector. With this feature enabled, you can move program windows to/from the computer LCD and the external monitor.

Power management

The power management system incorporates an "automatic LCD dim" feature that automatically dims the LCD when the computer is powered by a battery pack to conserve battery power. See "Power Management" on page 26 for more information on power management features.

Opening and closing the display

To open the display, slide the display cover latch to the left and lift up the cover. Then tilt it to a comfortable viewing position. The computer employs a microswitch that turns off the display (and enters standby mode) to conserve power when you close the display cover, and turns it back on when you open the display cover.

NOTE: If an external monitor is connected, the computer turns off the display (but does not enter standby mode) when you close the display cover.

To close the display cover, fold it down gently until the display cover latch clicks into place.

WARNING: To avoid damaging the display, do not slam it when you close it. Also, do not place any object on top of the computer when the display is closed.

System Block Diagram

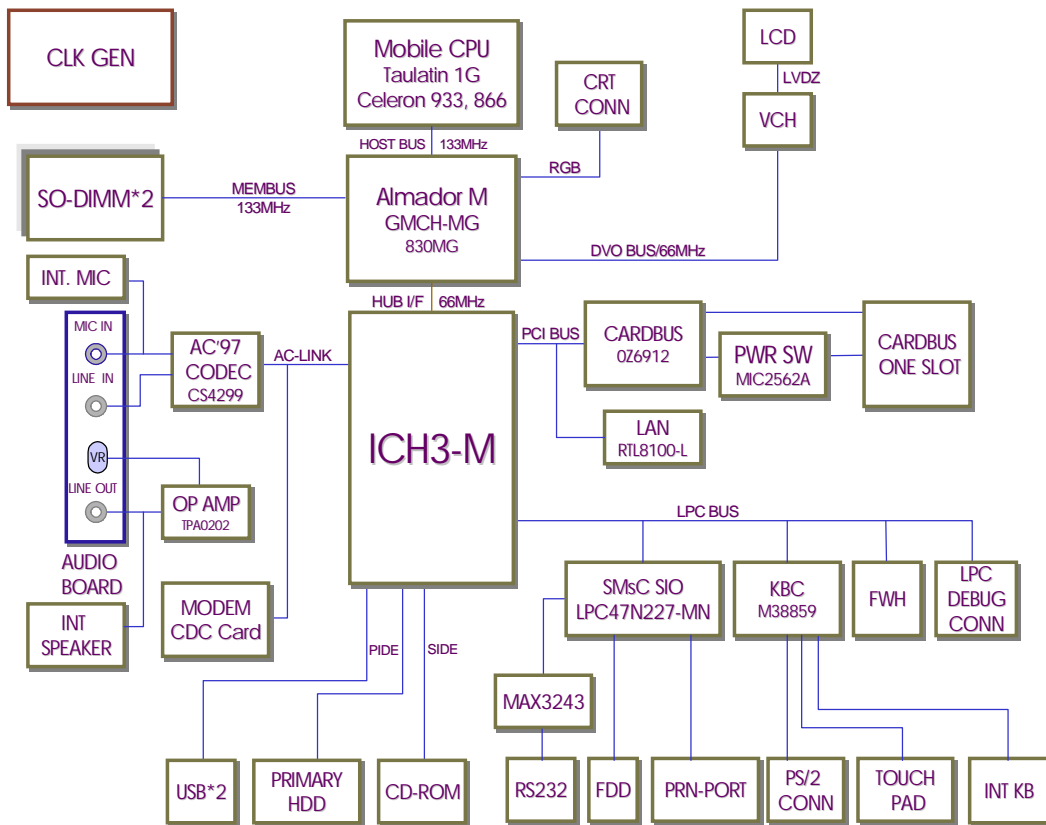

Board Layout

Top View

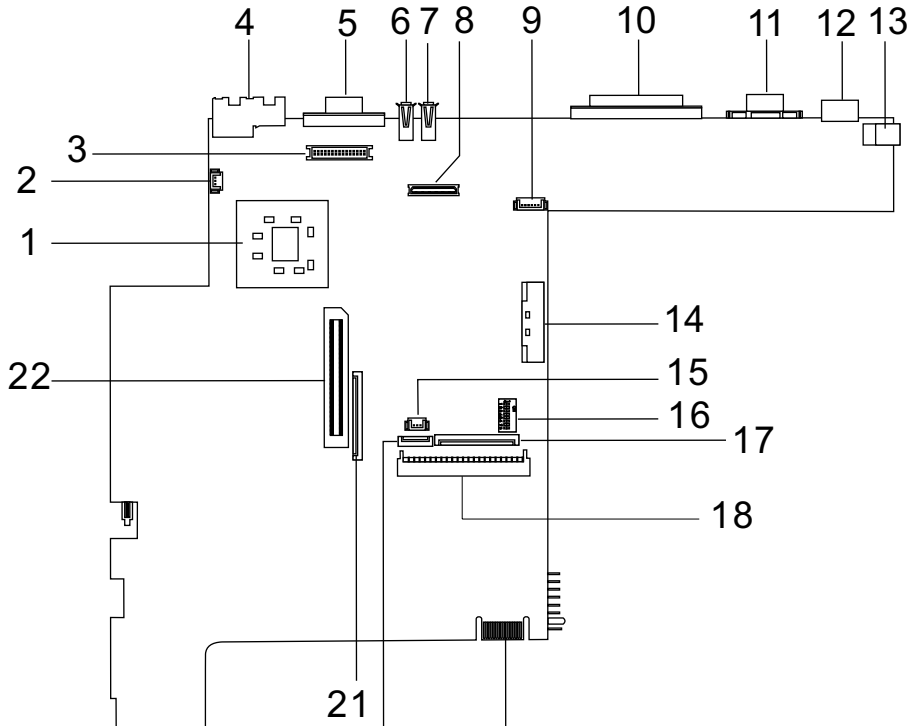

- | | | | |
|----|-----------------------|----|-----------------------------------|
| 1 | CPU (on board) | 12 | PS/2 Port |
| 2 | Fan Connector | 13 | DC-in Port |
| 3 | Inverter connector | 14 | CD-ROM Connector |
| 4 | RJ45+RJ11 | 15 | RTC battery connecto |
| 5 | External Display Port | 16 | Switch |
| 6 | USB Port 0 | 17 | Internal Keyboard Cable Connector |
| 7 | USB Port 1 | 18 | HDD Connector |
| 8 | LCD Connecto | 19 | Golden Finger |
| 9 | Hot Key Connector | 20 | TouchPad Cable Connector |
| 10 | Parallel Port | 21 | FDD Connector |
| 11 | Serial Port | 22 | Cardbus Connector |

Bottom View

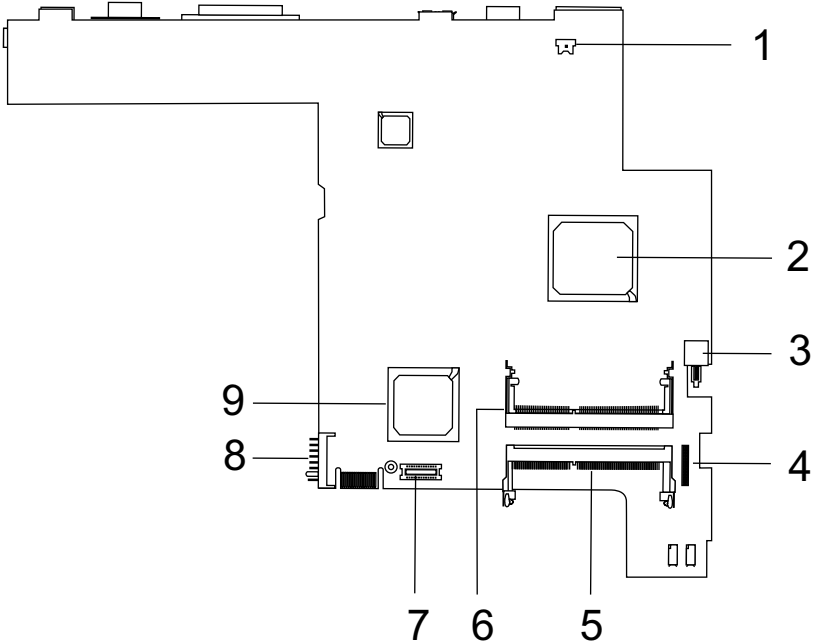

- | | | | |
|---|-----------------------|---|----------------------------|
| 1 | Modem Connector | 6 | DIMM 1 Socket |
| 2 | North Bridge(82830MG) | 7 | Modem Card Cable Connector |
| 3 | Power Switch | 8 | Battery Connecto |
| 4 | Audio Board Connector | 9 | South Bridge (ICH3-M) |
| 5 | DIMM 2 Socket | | |

Panel

Ports allow you to connect peripheral devices to your computer as you would with a desktop PC.





Front Panel



#	Item	Description
1	Display screen	Also called LCD (Liquid Crystal Display), displays computer output.
2	Touchpad	Touch-sensitive pointing device which functions like a computer mouse.
3	Floppy activity indicator	LED (light-emitting diodes) that turn on and off when the floppy is active.
4	Floppy drive	Internal diskette drive, accepts 3.5-inch floppy diskettes
5	Floppy disk eject button	Push this button to eject the floppy disk
6	Click button (left, center and right)	The left and right buttons function like the left and right mouse buttons, the center button serves as a scroll up/down button.
7	Palmrest	Comfortable support area for your hands when you use the computer.
8	Keyboard	Inputs data into your computer.
9	Status indicators	LEDs (Light Emitting Diodes) that turn on and off to show the status of the computer and its functions and components.

Left Panel



#	Icon	Item/ Port	Connects to...
1		Security keylock	Kensington-compatible key-based computer security lock.
2		PCMCIA (PC card) Port	Connects to one Type II or one Type III 16-bit PC card or 32-bit CardBus PC Card.
3		Eject button	Eject PC cards from the card slots.
4		Power switch	Turns on the computer power.
5		Speaker/ headphone-out jack	Connects to audio line-out devices (e.g., speakers, headphones)
6		Line-in jack	Accepts audio line-in devices (e.g., audio CD player, stereo walkman).
7		Microphone-in jack	Accepts a mono/stereo condenser microphone.
8		Volume control	Controls the volume of the speakers.
9		Video capture kit slot	Accepts the video capture kit option on the left side of the computer.

Right Panel





#	Icon	Item/ Port	Connects to...
1		Video capture kit slot	Accepts the video capture kit option on the right side of the computer.
2		Battery bay	Houses the computer's battery pack.
3		AcerMedia drive	Houses removable media drive modules.
4		LED indicator	Lights up when the AcerMedia drive is active.
5		Eject button	Ejects the compact disc from the drive.
6		Emergency eject slot	Ejects the compact discs when the computer is turned off.
7		Power Jack	Connects to an AC adapter

Rear Panel

I



#	Icon	Port	Connects to...
1		PS/2 port	Connects to any PS/2-compatible devices (e.g., PS/2 keyboard/mouse/keypad)
2		Serial port	Connects to a serial device (e.g., serial mouse)
3		Parallel port	Connects to a parallel device (e.g., parallel printer)
4		USB port (two)	Connects to any Universal Serial Bus devices(e.g., USB mouse, USB camera).

#	Icon	Port	Connects to...
5		External display port	Connects to a display device (e.g., external monitor, LCD projector) and displays up to 64K colors at 1280x1024 resolution
6		Modem jack	Connects to the phone line
7		Network jack	Connects to an Ethernet 10/100-based network

Bottom Panel

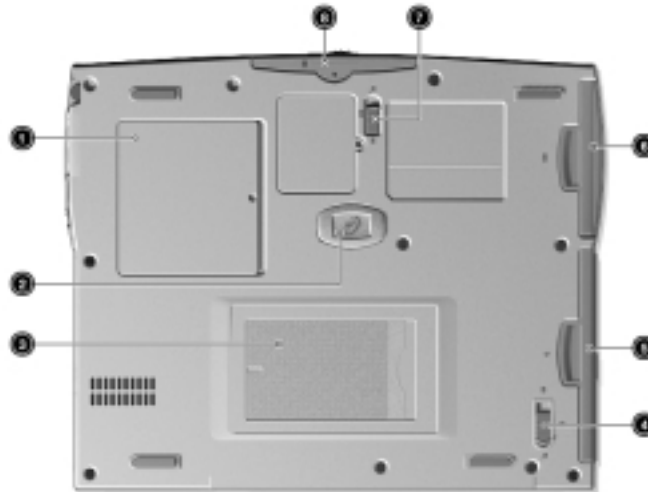







#	Item	Description
1	Memory compartment	Houses the computer's main memory.
2	Hard disk anti-shock protection	Protects your hard disk against shocks.
3	Personal identification slot	Insert a business card or similar-sized identification card to personalize your computer.
4	AcerMedia bay release latch	Unlatches the AcerMedia drive for removal or swapping.
5	AcerMedia bay	Houses an AcerMedia drive module.
6	Battery bay	Houses the computer's battery pack.
7	Battery release latch	Unlatches the battery to remove the battery pack.
8	Hard disk bay	Houses the computer's hard disk (secured by a screw).

Indicators

The computer has six easy-to-read status icons on the right of the display screen.



The Power and Standby status icons are visible even when you close the display cover so you can see the status of the computer while the cover is closed.

#	Icon	Function	Description
1		Power	Lights when the computer is on.
2		Sleep	Lights when the computer enters Standby mode and blinks when it enters into or resumes from hibernation mode.
3		Media Activity	Lights when the floppy drive, hard disk or AcerMedia drive is active.
4		Battery Charge	Lights when the battery is being charged.
5		Caps Lock	Lights when Caps Lock is activated.
6		Num Lock (Fn-F11)	Lights when Numeric Lock is activated.

Keyboard

The keyboard has full-sized keys and an embedded keypad, separate cursor keys, two Windows keys and twelve function keys.

Special keys

Lock keys

The keyboard has three lock keys which you can toggle on and off.

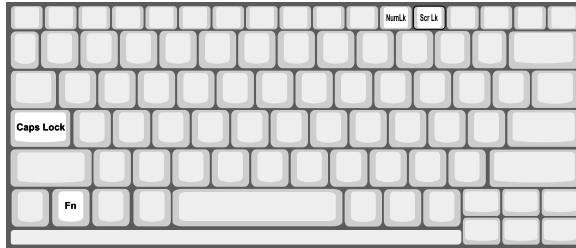

Lock key	Description
Caps Lock	When Caps Lock is on, all alphabetic characters typed are in uppercase.
Num Lock (Fn-F11)	When Num Lock is on, the embedded keypad is in numeric mode. The keys function as a calculator (complete with the arithmetic operators), -, *, and /). Use this mode when you need to do a lot of numeric data entry. A better solution would be to connect an external keypad.
Scroll Lock (Fn-F12)	When Scroll Lock is on, the screen moves one line up or down when you press the up or down arrow keys respectively. Scroll Lock does not work with some applications.

Embedded numeric keypad

The embedded numeric keypad functions like a desktop numeric keypad. It is indicated by small characters located on the upper right corner of the keycaps. To simplify the keyboard legend, cursor-control key symbols are not printed on the keys.











Desired access	Num lock on	Num lock off
Number keys on embedded keypad	Type numbers in a normal manner.	
Cursor-control keys on embedded keypad	Hold Shift while using cursor-control keys.	Hold Fn while using cursor-control keys.
Main keyboard keys	Hold Fn while typing letters on embedded keypad.	Type the letters in a normal manner.

NOTE: If an external keyboard or keypad is connected to the computer, the Num Lock feature automatically shifts from the internal keyboard to the external keyboard or keypad.

Windows keys

The keyboard has two keys that perform Windows-specific functions.



Keys	Description
Windows logo key 	Start button. Combinations with this key perform shortcut functions. Below are a few examples: <ul style="list-style-type: none">  + Tab (Activates next taskbar button)  + E (Explores My Computer)  + F (Finds Document)  + M (Minimizes All) Shift +  + M (Undoes Minimize All)  + R (Displays the Run... dialog box)
Application key 	Opens a context menu (same as a right-click).

Hot Keys

The computer employs hot keys or key combinations to access most of the computer's controls like screen contrast and brightness, volume output and the BIOS Utility.

To activate hot keys, press and hold the **Fn** key before pressing the other key in the hot key combination.

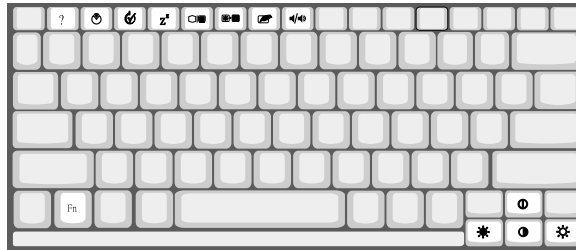

Hot Key	Icon	Function	Description
Fn-F1	?	Hotkey help	Displays a list of the hotkeys and their functions.
Fn-F2	Ⓜ	Setup	Accesses the notebook configuration utility.
Fn-F3	Ⓜ	Power Scheme Toggle	Switches between the power management scheme used by the computer (function available if supported by operating system).
Fn-F4	Z ^Z	Sleep	Puts the computer in Sleep mode.
Fn-F5	Ⓜ	Display toggle	Switches display output between the display screen, external monitor (if connected) and both the display screen and external monitor.
Fn-F6	Ⓜ	Screen blank	Turns the display screen backlight off to save power. Press any key to return.
Fn-F7	Ⓜ	Touchpad Toggle	Turns the internal touchpad on and off.
Fn-F8	🔊	Speaker on/off	Turns the speakers on and off; mutes the sound.
Fn-↑	Ⓜ	Contrast up	Increases the screen contrast (available only for models with HPA displays).
Fn-↓	Ⓜ	Contrast down	Decreases the screen contrast (available only for models with HPA displays).
Fn-→	☀️	Brightness up	Increases the screen brightness.
Fn-←	☀️	Brightness down	Decreases the screen brightness.

Launch Keys

Located at the top of the keyboard are four buttons. These buttons are called launch keys. They are designated as key 1, key 2, key 3 and key 4. By default, key 1 is used to launch the internet browser and key 2 is used to launch the e-mail application. Keys 3 and 4 starts the Launch Manager application. All four keys can be set by the user. To set the launch keys, run the Acer Launch Manager.



Touchpad

The built-in touchpad is a PS/2-compatible pointing device that senses movement on its surface. This means that the cursor responds as you move your finger on the surface of the touchpad. The central location on the palmrest provides optimum comfort and support.

NOTE: When using an external USB or serial mouse, you can press **Fn-F7** to disable the touchpad. If you are using an external PS/2 mouse, the touchpad is automatically disabled.



Touchpad basics

The following items teach you how to use the touchpad:



1. Move your finger across the touchpad to move the cursor.
2. Press the left (1) and right (3) buttons located on the edge of the touchpad to do selection and execution functions. These two buttons are similar to the left and right buttons on a mouse. Tapping on the touchpad produces similar results.
3. Use the center (2) buttons (top and bottom) to scroll up or down a page. This button mimics your cursor pressing on the right scroll bar of Windows applications.

Function	Left Button	Right Button	Center Button	Tap
Execute	Click twice quickly			Tap twice (at the same speed as double-clicking a mouse button)
Select	Click once			Tap once
Drag	Click and hold, then use finger to drag the cursor on the touchpad			Tap twice (at the same speed as double-clicking a mouse button) then hold finger to the touchpad on the second tap and drag the cursor
Access context menu		Click once		
Scroll			Click and hold the up/down buttons	

NOTE: Keep your fingers dry and clean when using the touchpad. Also keep the touchpad dry and clean. The touchpad is sensitive to finger movements. Hence, the lighter the touch, the better the response. Tapping harder will not increase the touchpad's responsiveness.

Hardware Specifications and Configurations

System Board Major Chips

Item	Controller
System core logic	Intel 830 MG with VGA integrated Intel ICH3-M with Audio integrated
Super I/O controller	SMCLPC4L47M227
Audio controller	Intel ICH
Video controller	Intel 830MG
Hard disk drive controller	Embedded in Intel ICH3-M
Keyboard controller	Mitsubish 38859F
RTC	BQ3285LFHP

Processor

Item	Specification
CPU type	Intel Mobile PIII with 512KB Cache Intel Celeron 1.06GHz processor with 256KB cache
CPU package	To PIII 1GHz uFCBGA2 To Celeron 1.06GHz uFPGA
CPU core voltage	1.7V
CPU I/O voltage	1.25V

BIOS

Item	Specification
BIOS vendor	Acer BIOS
BIOS Version	A0E0
BIOS ROM type	Flash ROM
BIOS ROM size	512KB
BIOS package	32 Pin PLCC
Supported protocols	ACPI 2.0b, APM 1.2, PC Card 95, SM BIOS 2.3, EPP/IEEE 1284, ECP/IEEE 1284 1.7 & 1.9, IrDA, PCI 2.1, PnP 1.0a, PS/2 keyboard and mouse, USB, VESA VGA BIOS, DDC-2B, CD-ROM bootable, Windows keyboard Microsoft Simple Boot Flag
BIOS password control	Set by switch, see SW setting

Second Level Cache

Item	Specification
Cache controller	Built-in CPU
Cache size	128KB
1st level cache control	Always Enable
2nd level cache control	Always Enable
Cache scheme control	Fixed-in write back

System Memory

Item	Specification
Memory controller	Intel 830MG
Onboard memory size	0MB
DIMM socket number	2 Sockets
Supports memory size per socket	128/256/512 MB
Supports maximum memory size	1024 MB (512MB x 2)
Supports DIMM type	SDRAM
Supports DIMM Speed	133 MHz
Supports DIMM voltage	3.3 V
Supports DIMM package	144-pin so-DIM
Memory module combinations	You can install memory modules in any combinations as long as they match the above specifications .

Memory Combinations

Slot 1	Slot 2	Total Memory
0MB	128MB	128 MB
128MB	0MB	128 MB
64MB	128MB	192 MB
128MB	64MB	192 MB
128MB	128MB	256 MB
256MB	0MB	256MB
0MB	256MB	256MB
256MB	64MB	320MB
64MB	256MB	320MB
256MB	128MB	384MB
128MB	256MB	384MB
256MB	256MB	512MB
0MB	512MB	512MB
512MB	128MB	640MB
256MB	512MB	768MB
128MB	512MB	640MB
512MB	256MB	768MB
256MB	128MB	384MB
128MB	256MB	384MB
512MB	512MB	1024MB
0MB	512MB	512MB

Above table lists some system memory configurations. You may combine DIMMs with various capacities to form other combinations.

NOTE: The shipping specification for DIMM combination is 64MB in slot 1.

Modem Interface

Item	Specification
Chipset	Ambit MDC module with Lucent modem controller
Fax modem data baud rate (bps)	14.4K
Data modem data baud rate (bps)	56K
Supports modem protocol	V.90MDC
Modem connector type	RJ11
Modem connector location	Rear side

Floppy Disk Drive Interface

Item	Specification		
Vendor & model name	Mitsumi D353G W/I BEZ MCI JU-226A033		
Floppy Disk Specifications			
Media recognition	2DD (720KB)	2HD (1.2 MB, 3 mode)	2HD (1.44MB)
Sectors/track	9	15	18
Tracks	80	80	80
Data transfer rate (Kbit/s)	1 MB	1.6 MB	2 MB
Rotational speed (RPM)	300	360	300
Read/write heads	2		
Encoding method	MFM		
Power Requirement			
Input Voltage (V)	+5V		

Hard Disk Drive Interface

Item	Specification	
Vendor & Model Name	IBM (IC25N010ATD)	IBM (IC25N020ATD)
Capacity (MB)	10000	20000
Bytes per sector	512	512
Logical heads	16	16
Logical sectors	63	63
Drive Format		
Logical cylinders	16383	16383
Physical read/write heads	2	3
Disk	1	2
Spindle speed (RPM)	4200RPM	4200RPM
Performance Specifications		
Buffer size	512KB	2MB
Interface	ATA-5	ATA-5
Data transfer rate (disk buffer, Mbytes/s)	105-199	121-216
Data transfer, rate (host-buffer, Mbytes/s)	100 MB/Sec	
DC Power Requirements		
Voltage tolerance	5 +/- 5%	5 +/- 5%

CD-ROM Interface

Items	Specification	
Vendor & Model Name	MKE CR-177-B/D	Mitsumi SR-243T
Performance Specification		
Transfer rate	CAV Mode: 775~1800 blocks/sec Mode 1: 1550~3600 kBytes/sec Mode 2: 1768~4106kBytes/sec	Read Sustained: 1545~3600 KB/sec Programmed I/O: 16.7 MB/sec Max. (Mode 0~4) Multi-word DMA: 16.7 MB/sec Max. (Mode 0~2) Ultra DMA: 33.3MB/sec Max.
Access time (typ.)	Random: 100 ms Full Stroke: 200 ms	Random: 115 ms Full Stroke: 250 ms
Rotation speed	5000 rp	5136 rp
Data Buffer Capacity	128 KB	128 KB
Interface	IDE	IDE
Applicable disc format	CD-Audio, CD-ROM (mode 1 and Mode 2), CD-ROM XA (mode 2, form 1 and form 2), CD-I (mode 2, form 1 and for 2), CD-I Ready, CD-I Bridge, Photo CD, CD-WO, Video CD, Enhanced Music CD (CD Plus), CD-RW	CD/CD-ROM(12cm,8cm), CD-R, CD-RW, CD-DA, CD-ROM (Mode 1, Mode2), CD-ROM XA (Mode 2, Form1 and For 2), Photo CD (Single, Multi- session), Enhanced CD
Loading mechanis	Drawer with soft eject and emergency eject hole	Drawer with soft eject and emergency eject hole
Power Requirement		
Input Voltage	+5V[DC]±5%	+5V[DC]±5%

DVD-ROM Interface

Item	Specification	
Vendor & model name	MKE SR-8176-BAA2	
Performance Specification	With CD Diskette	With DVD Diskette
Transfer rate (KB/sec)	Average Sustained: CAV mode 775~1800 blocks/sec (10.3X to 24X) 1550~3600kBytes/sec (Mode 1) 1768~4106 kBytes/sec (Mode 2)	DVD-5: Normal Speed (1X) 11.08 Mbits/sec CAV mode 36.67~88.64 Mbits/sec DVD-9/DVD-R: Normal Speed (1X) 11.08 Mbits/sec CAV mode 36.67~88.64 Mbits/sec
Average Full Access time (typ.)	Random (*1) CAV mode 110 msec typical 150 msec average max Full Stroke (*2) CAV mode 200 msec typical 260 msec average max	DVD-5: Random (*4) 150 msec typical 200 msec average max Full Stroke (*5) 300 msec typical 400 msec average max DVD-9: Random (*7) 170 msec typical 230 msec average max Full Stroke (*8) 340 msec typical 470 msec average max

DVD-ROM Interface

Item	Specification
Data Buffer Capacity	512 kBytes
Interface	IDE
Applicable disc format	DVD: DVD-5, DVD-9, DVD-10, DVD-R (3.95G) CD: CD-Audio, CD-ROM (mode 1 and mode 2), CD-ROM XA (mode 2, form 1 and form 2), CD-I (mode 2, form 1 and form 2), CD-I Ready, CD-I Bridge, CD-WO, CD-RW, Photo CD, Video CD, Enhanced Music CD, CD-TEXT
Loading mechanism	Soft eject (with emergency eject hole)
Power Requirement	
Input Voltage	+5V[DC]±5

(*1) Average of Data read over the whole area from 00 min. 02 sec. 00 block to 59 min. 58 sec. 74 block more than 2000 times including latency and layered error correction time.

(*2) From 00 min. 02 sec. 00 block to 59 min. 58 sec. 74 block including latency and layered error correction time.

(*3) Disc: MNSU-005

(*4) Average of Data read over the whole area from starting data recorded area (LBA:0) to maximum data recorded area (LBA:23197F), more than 2000 times including latency and layered error correction time.

(*5) from starting data recorded area (LBA:0) to maximum data recorded area (LBA:23197F) including latency and layered error correction time.

(*6) Disk: MKE-D551.

(*7) Average of Data read over the whole area from starting data recorded area (LBA:0) to maximum data recorded area (LBA:3FA0DF), more than 2000 times including latency and layered error correction time.

(*8) from starting data recorded area (LBA:0) to maximum data recorded area (LBA:3FA0DF) including latency and layered error correction time.

(*9) Disk: ODSC-PARA

Audio Interface

Item	Specification
Audio Controller	Cirrus Logic CS4299-XQ
Audio onboard or optional	Built-in
Mono or Stereo	Stereo
Resolution	20 bit stereo Digital to Analog converter 18 bit stereo Analog to Digital converter
Compatibility	Microsoft PC98/PC99, AC97 2.1
Mixed sound source	Line-in, CD, Video, AUX
Voice channel	8/16 bit, mono/stereo
Sampling rate	44.1 KHz
Internal microphone	Yes
Internal speaker / Quantity	Yes
Supports PnP DMA channel	DMA channel 0 DMA channel 1
Supports PnP IRQ	IRQ3, IRQ5, IRQ7, IRQ9, IRQ10, IRQ11

Video Interface

Item	Specification
Vendor & Model Name	Intel 830MG
Chip voltage	Core / 2.5V, 1.5V, 1.8V
Supports ZV (Zoomed Video) port	NO
Graph interface	2X AGP (Accelerated Graphic Port) Bus

Video Interface

Item	Specification
Maximum resolution (LCD)	1024 x768 (32bit colors)
Maximum resolution (CRT)	1024x768 (32 bit colors) 1280x1024 (32 bit colors) 1600x1200 (32 bit colors)

Video Memory

Item	Specification
Fixed or upgradeable	Fixed, share the system memory
Video memory size	8MB

Video Resolutions Mode

Resolution	Refresh Rate	
	CRT Only	LCD/CRT Simultaneous
640x480x256	90	60
640x480x64K	90	60
640x480x16M	90	60
800x600x256	90	60
800x600x64K	90	60
1024x768x256	90	60

Parallel Port

Item	Specification
Parallel port controller	LPC47N227
Number of parallel port	1
Location	Rear side
Connector type	25-pin D-type
Parallel port function control	Enable/Disable by BIOS Setup
Supports ECP/EPP	Yes (set by BIOS setup)
Optional ECP DMA channel (in BIOS Setup)	DMA channel 1 and 3
Optional parallel port I/O address (in BIOS Setup)	378h, 278h, 3BCh
Optional parallel port IRQ (in BIOS Setup)	IRQ7, IRQ5

Serial Port

Item	Specification
Serial port controller	LPC47N227
Number of serial port	1
Supports 16550 UART	Yes
Connector type	9--pin D-type
Location	Rear side
Serial port function control	Enable/Disable by BIOS Setup
Optional serial port (in BIOS Setup)	3F8h, 2F8h, 3E8h, 2E8h

Serial Port

Item	Specification
Optional serial port IRQ (in BIOS Setup)	IRQ4, IRQ3

USB Port

Item	Specification
USB Compliancy Level	1.1
OHCI	USB 1.1
Number of USB port	2
Location	Rear side
Serial port function control	Enable/Disable by BIOS Setup

PCMCIA Port

Item	Specification
PCMCIA controller	O2-Micro Cardbus Controller OZ6912T-U
Supports card type	Type III/II
Number of slots	One type III or one type II
Access location	Left side
Supports ZV (Zoomed Video) port	Yes
Supports 32 bit CardBus	Yes (IRQ9)

Keyboard

Item	Specification
Keyboard controller	Mitsubishi M38859FFHP
Keyboard vendor & model name	API
Total number of keypads	84-/85/87- key
Windows 95 keys	Yes
Internal & external keyboard work simultaneously	Yes

Battery

Item	Specification
Vendor & model name	SIMPLO
Battery Type	Li-ION / Ni-MH
Pack capacity	4000mAH / 4500mAH
Cell voltage	3.7V / 1.2V
Number of battery cell	8
Package configuration	4529 / 8S
Package voltage	14.8V / 9.6V

DC-DC/Charger Converter

Item	Specification
Vendor & Model Name	Acer
Input Voltage	AC Adapter or Battery: 8V - 19VDC
DC-DC Converter Output	

DC-DC/Charger Converter

Item	Specification		
Output Rating	+5V	3.3V	12V
Current (w/load, A)	0~5A	0~4A	120mA
Charger Output	Li-ION	Ni-MH	
Normal charge (charge while system is not operative)	2.8A	2.25V	
Background charge (charge even system is still operative)	0.8A		
Battery-low 2 level (V)	12.5V	8V	
Battery-low 3 level (V)	10V	7.5V	
Protection			
Charger protection	Over Current Protection		
DC/DC converter protection	OCP (Over Current Protection, A) OVP (Over Voltage Protection, V) UVP (Under Voltage Protection, V)		

DC-AC LCD Inverter

Item	Specification
Vendor & model name	Ambit
Input voltage (V)	8 ~ 21V
Input current (mA)	1A (max.)
Output voltage (Vrms, no load)	1400Vrm
Output voltage frequency (kHz)	40 ~ 70KHz
Output Current/Lamp	5.5 mA ~ 6.5mA

NOTE: DC-AC inverter is used to generate very high AC voltage, then support to LCD CCFT backlight user, and is also responsible for the control of LCD brightness. Avoid touching the DC-AC inverter area while the system unit is turned on.

NOTE: There is an EEPROM in the inverter, which stores its supported LCD type and ID code. If you replace a new inverter or replace the LCD with a different brand, use Inverter ID utility to update the ID information.

LCD

Item	Specification	
Vendor & model name	13.3" AV B133XN04	14.1" AV B141XN04/3
Mechanical Specifications		
LCD display area (diagonal, inch)	13.3	14.
Display technology	TFT	TFT
Resolution	XVGA (1024x768)	XVGA (1024x768)
Support colors	262K	262K
Optical Specification		
Brightness control	Keyboard hotkey	Keyboard hotkey
Contrast control	None	None
Electrical Specification		
Supply voltage for LCD display (V)	3.3 (typ.)	3.3 (typ.)

LCD

Item	Specification	
Supply voltage for LCD backlight (Vrms)	650 (typ.)	650 (typ.)

AC Adapter

Item	Specification
Vendor & model name	Delta ADP-60DB
Input Requirements	
Maximum input current (A, @90Vac, full load)	1.5 A @ 115Vac 1.0 A @ 230Vac
Nominal frequency (Hz)	50-60
Frequency variation range (Hz)	47-63
Input voltage range (Vrms)	90-270
Inrush current	The maximum inrush current will be less than 50A and 100A when the adapter is connected to 115Vac and 230Vac respectively.
Efficiency	It should provide an efficiency of 80% minimum, when measured at maximum load under 115Vac.
Output Ratings (CV mode)	
DC output voltage	19V
Noise + Ripple	300mVp-pmax (20 MHz bandwidth)
Load	0(min) 3.16A(max)
Output Ratings (CC mode)	
DC output voltage	19V +/-1.0V for CV mode
Constant current mode	3.6 +/- 0.3A
Dynamic Output Characteristics	
Turn-on delay time	3 sec (@ 115Vac)
Hold up time	5ms (@115Vac, Full load)
Over Voltage Protection (OVP)	24V
Short circuit protection	3.9A max can be protected and output can be shorted without damage
Electrostatic discharge (ESD)	15KV (at air discharge) 8KV (at contact discharge)
Dielectric Withstand Voltage	
Primary to secondary	3000Vac
Leakage current	0.25 mA max. (@ 254Vac, 60Hz)
Regulatory Requirements	<p>Safety Requirements:</p> <ol style="list-style-type: none"> 1.The subject product rated 100-120V 60Hz must be listed under UL 1950 and certified with SCA Standard C22.2 No.950. 2.The subject product rated 200-240V 50Hz must comply with low voltage directive 73/23EEC. <p>EMI Requirements:</p> <ol style="list-style-type: none"> 1.The subject product rated 100-120V 60Hz must meet the EMI requirements of FCC part 15, Subpart B for Class B Digital Device and get FCC Certification before marketing into USA and Canada. 2.The subject product rated 200-240V 50Hz must meet the EMC Directive 89/336/EEC. 3.The subject product rated 100-120V must meet the VCCI-2 EMI requirements.

Power Management

Power Saving Mode	Phenomenon
Standby Mode Enter Standby Mode when 1. Standby/Hibernation hot-key is pressed and system is not ready to enter Hibernation mode. 2. System standby/ Hibernation timer expires and system is not ready to enter Hibernation mode.	<input type="checkbox"/> The buzzer beeps <input type="checkbox"/> The Sleep indicator lights u
Hibernation Mode Enter Hibernation Mode (suspend to HDD) when 1. Hibernation hot-key is pressed and system is ready to enter Hibernation mode 2. System Hibernation timer expires and system is ready to enter Hibernation mode.	<input type="checkbox"/> All power shuts off
Display Standby Mode Keyboard, built-in touchpad, and an external PS/2 pointing device are idle for a specific period.	<input type="checkbox"/> The display shuts off
Hard Disk Standby Mode Hard disk is idle within a specified period of time.	<input type="checkbox"/> Hard disk drive is in standby mode. (spindle turned-off)

Environmental Requirements

Item	Specification
Temperature	
Operating	+5~+35 °C
Non-operating	-20~+60 °C
Humidity	
Operating	20% to 85% RH, non-condensing
Non-operating	20% to 90% RH, non-condensing
Vibration	
Operating (unpacked)	5~25.6Hz: 0.38mm (peak to peak) 25.6~250Hz: 0.5G
Non-operating (unpacked)	5~27.1Hz: 0.6G 27.1~50Hz: 0.04mm (peak to peak) 50~500Hz: 2.0G
Non-operating (packed)	5~62.6Hz: 0.51mm (peak to peak) 62.6~500Hz: 4G

Mechanical Specification

Item	Specification
Dimensions	311(W) x 260.5(D) x 36.7(H)mm
Weight	6.2 lbs for 14.1" TFT model and CD-ROM
I/O Ports	One type II or one type III PCMCIA (PC Card) port, one RJ-11 port, one DC-in port, one parallel port, one serial port, one PS/2 keyboard/mouse port, two USB port, one line-in jack, one speaker/headphone-out jack, one microphone-in jack, one external display port

Mechanical Specification

Item	Specification
Drive Bays	One
Material	Plastic
Indicators	Power-on, Standby, Battery Status, Media Access, CapsLock and NumLock
Switch	Power

Memory Address Map

Memory Address	Size	Function
00000000-0009FFFF	640 KB	Base memory
80600000-80600FFF	4 KB	Intel 82830MG
80620000-8063FFFF	128 KB	
81000000-81FFFFFF	3 MB	
000A0000-000CFFFF	192 KB	
08000000-08000FFF	4 KB	
08001000-08001FFF	4 KB	
82400000-82400FFF	4 KB	USB
82200000-82200FFF	4 KB	Audio

I/O Address Map

I/O Address	Function
000-00F	DMA controller-1
020-021	Interrupt controller-1
040-043	Timer 1
060, 064	Keyboard controller 8742 chip select
061	System speake
066	ACPI Embedded Controller
070-073	System CMOS/RTC
080	Main board resources
081-08F	DMA Controller-1
0A0-0A1	Interrupt controller-2
0C0-0DF	DMA controller-2
0F0-0FF	Numeric data processor
170-177/376	2nd EIDE device (CD-ROM) select
1F0-1F7/3F6	1st EIDE device (hard drive) select
278-27F	Parallel port 3
2E8-2EF	Lucent Technologies Soft Modem AM
2F8-2FF	ALi Fast Infrared Controlle
378, 37F	Printer Port (LPT 1)
3B0-3BB, 3C0-3DF	Video Controller
3F0-3F5/3F7	Standard Floppy Disk Controller
3E8-3EF	COM3
3F8-3FF	COM1 orLT Win modem (optional)
480-48F, 4D6	DMA controller-1
4D0-4D1, CF8-CFF	PCI configuration registe

IRQ Assignment Map

Interrupt Channel	Function
NMI	System errors
IRQ0	System timer
IRQ1	Keyboard
IRQ2	Programmable interrupt controller
IRQ3	Reserved
IRQ4	COM1
IRQ5	Reserved
IRQ6	Floppy
IRQ7	LPT1
IRQ8	Real time clock
IRQ9	SCI
IRQ10	Audio/Mode
IRQ11	USB/VGA/Cardbus
IRQ12	PS2 pointing device
IRQ13	Numeric data processor
IRQ14	1st IDE device (hard disk)
IRQ15	2nd EIDE device (CD-ROM drive)

NOTE: IRQ settings may be changed by OS

DMA Channel Assignment

DMA Channel	Function
DRQ0	Not used
DRQ1	Not used
DRQ2	Flopp
DRQ3	Not used
DRQ4	DMA controller
DRQ5	Not used
DRQ6	Not used
DRQ7	Not used

System Utilities

BIOS Setup Utility

The BIOS Setup Utility is a hardware configuration program built into your computer's BIOS (Basic Input/Output System).

Your computer is already properly configured and optimized, and you do not need to run this utility. However, if you encounter configuration problems, you may need to run Setup. Please also refer to Chapter 4 Troubleshooting when problem arises.

To activate the BIOS Utility, press **F2** during POST (while the TravelMate logo is being displayed).

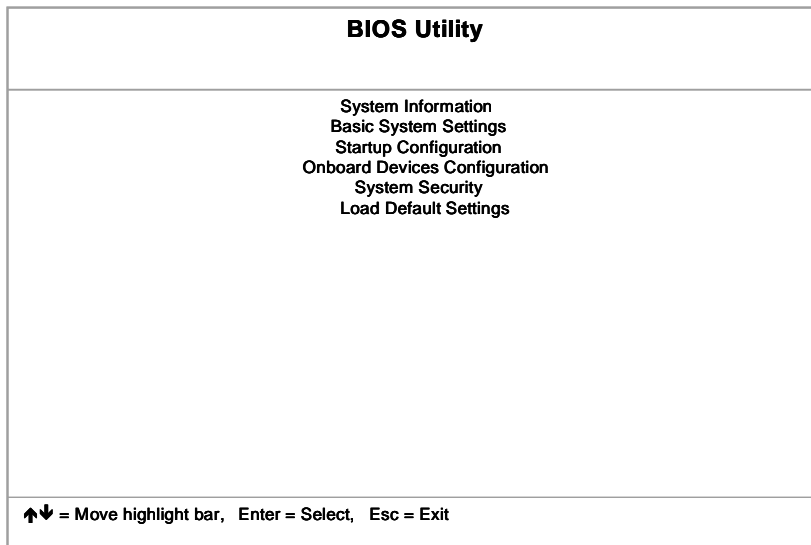

Multi-Boot Menu

Users can press F12 during POST to enter the Multi Boot Selection Menu. In this menu users can change boot device without entering BIOS SETUP utility.

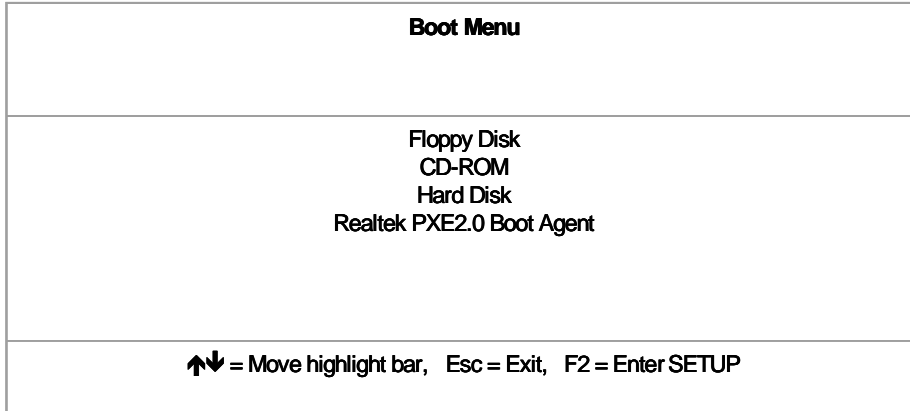



NOTE: If users disable the multi boot selection menu in BIOS SETUP utility, the message “ Press F12 to enter the multi boot selection menu” will not appear during POST.





NOTE: If users disable the “Boot from LAN” option in BIOS SETUP utility, then the option of Realtek PXE2.0 Boot Agent will not appear.

Navigating the BIOS Utility

There are six menu options: System Information, Basic System Settings, Startup Configuration, Onboard Device Configuration, System Security and Loading Default Settings.

To enter a menu, highlight the item using the  /  keys, then press .

Within a menu, navigate through the BIOS Utility by following these instructions:

- Press the  /  keys to move between the parameters.
- Press the  /  keys to change the value of a parameter.
- Press the  key while you are in any of the menu options to return to the main menu.

NOTE: You can change the value of a parameter if it is enclosed in square brackets. Navigation keys are shown at the bottom of the screen.

System Information

The System Information screen displays a summary of your computer hardware information.

System Information		Page 1/1
CPU Type & Speed	Celeron 933 MHz	
Floppy Disk Drive	1.44 MB 3.5-inch	
Hard Disk Drive	XXXXX MB	
HDD Serial Number	XXXXXXXXXXXXXXXXXXXXXXX	
System with	XXXROM Attached	
System BIOS Version	V3.3 R01-A1a	
VGA BIOS Version	XXXXXXXXXXXXXXXXXXXXXXX	
Serial Number	XXXXXXXXXXXXXXXXXXXXXXX	
Asset Tag Number	XXXXXXXXXXXXXXXXXXXXXXX	
Product Name	Falcon3M	
Manufacturer Name	Wistron	
LAN Device	Exist (MAC Address = XX:XX:XX:XX:XX:XX)	
UUID	XXXXXXXX-XXXX-XXXX-XXXX-XXXXXXXXXXXX	
↑↓ = Move highlight bar, ←→ = Change setting, F1 = Help		

NOTE: The screen above is a sample and may not reflect the actual data on your computer. “X” may refer to a series of numbers and/or characters.

The following table describes the information in this screen.

Parameter	Description
CPU Type & Speed	Describes the type of CPU installed in the system.
Floppy Disk Drive	Shows the floppy disk drive type (1.44 MB, 3.5-inch).
Hard Disk Drive	Shows the size or capacity of the hard disk.
HDD Serial Number	Shows the serial number of the hard disk.
System with	Shows the high-capacity disc drive installed.
System BIOS Version	Shows the system BIOS version.
VGA BIOS Version	Shows the video graphics accelerator BIOS version.
Serial Number	Shows the serial number of the computer.
Asset Tag Number	Shows the asset tag number of the computer.
Product Name	Shows the official name of the product.
Manufacturer Name	Shows the manufacturer of the computer.
LAN Device	Display the MAC address of the internal LAN.
UUID	Shows the universally unique identifier of your computer.

The items in this screen are important and vital information about your computer. If you experience computer problems and need to contact technical support, this data helps our service personnel know more about your computer.

Basic System Settings

The Basic System Settings screen allows you to set the system date and time.

Basic System Setting		page 1/1
Date	[Mon Jan 1, 2001]	
Time	[12:00]	
↑↓ = Move highlight bar, ←→ = Change setting, F1 = Help		

The following table describes the parameters in this screen.

Parameter	Description	Format
Date	Sets the system date.	DDD MMM DD, YYYY (day-of-the-week month day, year)
Time	Sets the system time.	HH:MM:SS (hour:minute:second)

Startup Configuration

The Startup Configuration screen contains parameter values that define how your computer behaves on system startup.

Startup Configuration		Page 1/1
Boot Display -----	[Both] /[Auto]	
Screen Expansion -----	[Enabled] /[Disabled]	
Hotkey Beep -----	[Enabled] /[Disabled]	
Fast Boot -----	[Enabled] /[Disabled]	
Boot on LAN-----	[Disabled] /[Enabled]	
Multi Boot Selection Menu -----	[Enabled] /[Disabled]	
CPU Power Management Mode -----	[Auto] /[Disabled]	
Boot Drive Sequence:		
1st. -----	[Floppy Disk]	
2nd. -----	[CD-ROM]	
3rd. -----	[Hard Disk]	
4th. -----	[-----]	
↑↓ = Move highlight bar, ← → = Change setting, F1 = Help		

The following table describes the parameters in this screen. Settings in **boldface** are the default and suggested parameter settings.

Parameter	Description	Options
Boot Display	Sets the display device during POST. When set to Auto , the computer automatically determines the display device. If an external display device (e.g., monitor) is connected, it becomes the boot display; otherwise, the computer's display screen is the boot display. When set to Both , the computer outputs to both the computer display screen and an external display device if one is connected.	Both or Auto
Screen Expansion	Expand the screen on the graphic/text mode. When it is disabled, the graphic/text mode expansion function is disabled and the graphic/text image will be centralized on the LCD screen. If it is enabled, the graphic/text image will be expanded to the full LCD screen.	Enabled or Disabled
Hotkey Beep	When enabled, the computer gives off a beep when a hotkey (key combination Fn+ F4) is pressed).	Enabled or Disabled
Fast Boot	Allows you to define your system's booting process; whether to skip some POST routines or proceed with the normal booting process. When it is enabled, the ACPI OS will communicate with BIOS to decide the next POST is fast or diagnostic.	Enabled or Disabled
Boot on LAN	When it is enabled, a remote host with an appropriate boot image can boot this computer via the internal LAN.	Disabled or Enabled
Multi Boot Selection Menu	When it is enabled, the user can press F12 key to enter the multi boot selection menu during POST. If it is disabled, the F12 key function should be disabled.	Enabled or Disabled
CPU Power Management Mode	When it is auto, system can support the stop clock function. When it is disabled, system will disable the stop clock function.	Auto or Disabled
Boot Drive Sequence	Specifies the order in which the computer starts up from. See the section below.	1st: Floppy Disk, 2nd: CD-ROM, 3rd: Hard Disk 4th: Realtek PXE2.0 Boot Agent

Setting the Boot Drive Sequence

The Boot Drive Sequence section lists boot priorities (1st, 2nd, 3rd and 4th) for bootable drives in your computer.

For example, the default value (1st:Floppy Disk, 2nd:CD-ROM, 3rd:Hard Disk and 4th: Realtek PXE2.0 Boot Agent) tells the computer to first search for a bootable floppy disk in the floppy drive. If it finds one present, it boots up from that floppy disk. If not, the computer continues to search for a bootable CD-ROM in the CD-ROM drive. If it cannot boot up from the CD-ROM drive, it continues by booting up from the hard disk and etc...

To set the boot drive sequence, use the **↑** / **↓** keys to select a priority level (1st, 2nd, 3rd and 4th), then use the **←** / **→** keys to select the device for that priority level.

Onboard Device Configuration

The parameters in this screen are for advanced users only. You do not need to change the values in this screen because these values are already optimized.

The Onboard Device Configuration screen assigns resources to basic computer communication hardware.

Onboard Devices Configuration		Page 1/1
Serial Port	[Enabled] / [Disabled]	
Base Address	[3F8h] /[2F8h]/[3E8h]/[2E8h]	
IRQ	[4] /[3]	
Parallel Port	[Enabled] / [Disabled]	
Base Address	[378h] /[278h]/[3BCh]	
IRQ	[7]/[5]	
Operation Mode	[Bi-directional] /[ECP] /[EPP] / [Standard]	
ECP DMA Channel	[1]/[3]	
↑↓ = Move highlight bar, ← → = Change setting, F1 = Help		

The following table describes the parameters in this screen. Settings in **boldface** are the default and suggested parameter settings.

Parameter	Description	Options
Serial Port	Enables or disables the serial port. The serial port is a PnP device. Enabled/Disabled setting won't affect the setting of the serial port in device manager of Windows. When enabled, you can set the base I/O address and interrupt request (IRQ) of the serial port.	Enabled or Disabled 3F8h , 2F8h, 3E8h or 2E8h 4 or 3
Parallel Port	Enables or disables the parallel port. The parallel port is a PnP device. Enabled/Disabled setting won't affect the setting of the parallel port in device manager of Windows. When enabled, you can set the base I/O address, interrupt request (IRQ) and operation mode of the parallel port. If operation mode is set to ECP, the direct memory access (DMA) channel of the parallel port is set to 1.	Enabled or Disabled 378h , 278h, or 3BCh 7 or 5 Bi-directional , EPP, ECP or Standard

NOTE: When the device is disabled, all the sub-items will be showed as [--].

System Security

The System Security screen contains parameters that help safeguard and protect your computer from unauthorized use.



System Security page 1/1	
Setup Password	[None] / [Present]
Power-on Password	[None] / [Present]
Hard Disk Password	[None] / [Present]
Processor Serial Number	[None] / [Present]
↑↓ = Move highlight bar, ←→ = Change setting, F1 = Help	

The following table describes the parameters in this screen. Settings in **boldface** are the default and suggested parameter settings.

Parameter	Description	Options
Setup Password	When set to present, this password protects the computer and the BIOS Utility from unauthorized entry. See the following section for instructions on how to set a password.	None or Present
Power-on Password	When set to present, this password protects the computer from unauthorized entry during power-on. See the following section for instructions on how to set a password.	None or Present
Hard Disk Password	This item appears only if the unit is business model. When set to present, this password protects the hard disk from unauthorized access. See the following section for instructions on how to set a password.	None or Present
Processor Serial Number	When set to present, the CPU serial number may be obtained via necessary utility. Note that the model with Celeron CPU doesn't support the CPU serial number feature and this item should be invisible.	None or Present

Setting a Password



Follow these steps:

1. Use the cursor  /  keys to highlight a Password parameter (Setup, Power-on or Hard Disk) and press the  key. The password box appears:



2. Type a password. The password may consist of up to eight characters (A-Z, a-z, 0-9).

IMPORTANT: Be very careful when typing your password because the characters do not appear on the screen.

3. Press  . Retype the password to verify your first entry and press  .

4. After setting the password, the computer automatically sets the chosen password parameter to Present.

Three password types protect your computer from unauthorized access. Setting these passwords creates several different levels of protection for your computer and data:

- Setup Password prevents unauthorized entry to the BIOS Utility. Once set, you must key-in this password to gain access to the BIOS Utility.
- Power-On Password secures your computer against unauthorized use. Combine the use of this password with password checkpoints on boot-up and resume from hibernation for maximum security.
- Hard Disk Password protects your data by preventing unauthorized access to your hard disk. Even if the hard disk is removed from the computer and moved to another computer, it cannot be accessed without the Hard Disk Password.

When a password is set, a password prompt appears on the left-hand corner of the display screen.

1. When the Setup Password is set, the following prompt appears when you press  to enter the BIOS Utility at boot-up.



Setup Password



Type the Setup Password and press  to access the BIOS Utility.



2. When the Power-on Password is set, the following prompt appears at boot-up.



Type the Power-on Password (a symbol appears for each character you type) and press  to use the computer. If you enter the password incorrectly, an **x** symbol appears. Try again and press .

3. When the Hard Disk Password is set, the following prompt appears at boot-up.



Type the Hard Disk Password (a symbol appears for each character you type) and press  to use the computer. If you enter the password incorrectly, an **x** symbol appears. Try again and press .

You have three chances to enter a password. If you successfully entered the password, the system starts Windows.



If you fail to enter the password correctly after three tries, the following message or symbol appears.

Setup

Incorrect password specified. System disabled.

Power-on/Hard Disk



To change a password, follow the same steps used to set a password.

To remove a password, follow the same steps used to set a password, except type nothing in the password boxes.

Load Default Settings

If you want to restore all parameter settings to their default values, select this menu item and press **ENTER**. The following dialog box displays.

Do you want to load default settings?

[Yes] [No]

If you would like to load factory- default settings for all parameters, use the cursor **←** / **→** keys to select **Yes**; then press **ENTER**. Choose **No** if otherwise.

BIOS Flash Utility

The BIOS flash memory update is required for the following conditions:

- New versions of system programs
- New features or options

Use the IFlash utility to update the system BIOS flash ROM.

NOTE: Do not install memory-related drivers (XMS, EMS, DPMS) when you use IFlash.

NOTE: This program contains a readme.txt file. This readme.txt file will introduce on how to use IFlash utility.

System Utility Diskette

This utility diskette is for the TravelMate 220/260 series notebook machine. You can find the utility in Service CD kit. It provides the following functions:

1. Panel ID Utility
2. Thermal & Fan Utility
3. Mother Board Data Utility

To use this diskette, first boot from this diskette, then a "Microsoft Windows ME Startup Menu" prompt you to choose the testing item. Follow the instructions on screen to proceed.

NOTE: This program contains a readme.txt file. This readme.txt file will introduce each test utility and its functions.

System Diagnostic Diskette

IMPORTANT: ¹The diagnostics program here that we used is called PQA (Product Quality Assurance) and is provided by Headquarters. You can utilize it as a basic diagnostic tool. To get this program, you can find it in the service CD kit.

To better fit local service requirements, your regional office MAY have other diagnostic program. Please contact your regional offices or the responsible personnel/channel to provide you with further technical details.

NOTE: This program contains a readme.txt file. This readme.txt file will introduce each test and its functions.

¹ New added description. Please pay attention to it.

Running PQA Diagnostics Program

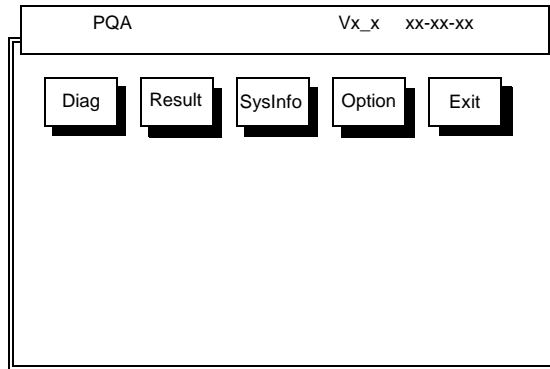

Press **←** / **→** to move around the main menu. Press **ENTER** to enable the selected option. The main options are Diag, Result, SysInfo, Option and Exit.

The Diag option lets you select testing items and times.

The following screen appears when you select Diag from the main menu.

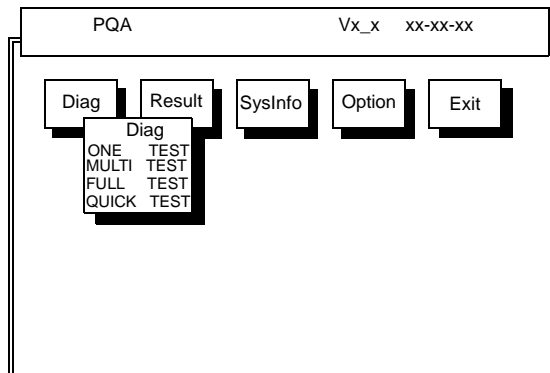

One Test performs a single test and Manual checks the selected test items in sequence.

Multi Test performs multiple tests of the selected items and check the selected test items in sequence.

Full Test performs all test items in detail for your system.

Quick Test performs all test items quickly for your system.

The screen below appears if you select MultiTest.

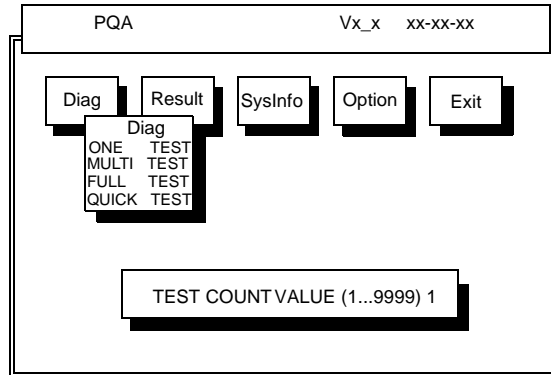

Specify the desired number of tests and press **ENTER**.

After you specify the number of tests to perform, the screen shows a list of test items (see below).

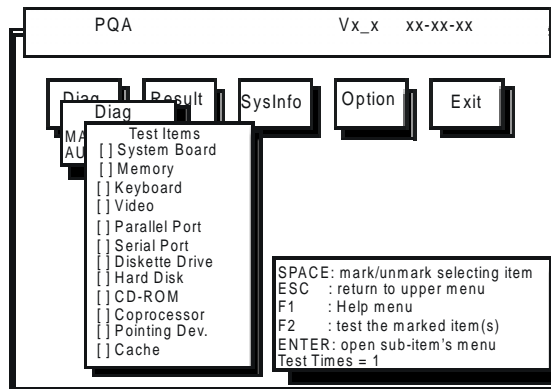

Move the highlight bar from one item to another. Press Space to enable or disable the item. Press **ENTER** to view the available options of each selected item. Press **ESC** to close the submenu.

The right corner screen information gives you the available function keys and the specified test number.

- Space: Enables/disables the item
- ESC: Exits the program
- F1: Help
- F2: Tests the selected item(s)
- Enter: Opens the available options
- Test Times: Indicates the number of tests to perform.

NOTE: The F1 and F2 keys function only after you finish configuring the Test option.

NOTE: When any errors are detected by diagnostic program, refer to "Index of PQA Diagnostic Error Code" for troubleshooting.

Machine Disassembly and Replacement

This chapter contains step-by-step procedures on how to disassemble the notebook computer for maintenance and troubleshooting.

To disassemble the computer, you need the following tools:

- Wrist grounding strap and conductive mat for preventing electrostatic discharge
- Flat-bladed screw driver
- Phillips screw driver
- Tweezers
- Flat-bladed screw driver or plastic stick

NOTE: The screws for the different components vary in size. During the disassembly process, group the screws with the corresponding components to avoid mismatch when putting back the components.

General Information

Before You Begin

Before proceeding with the disassembly procedure, make sure that you do the following:

1. Turn off the power to the system and all peripherals.
2. Unplug the AC adapter and all power and signal cables from the system.

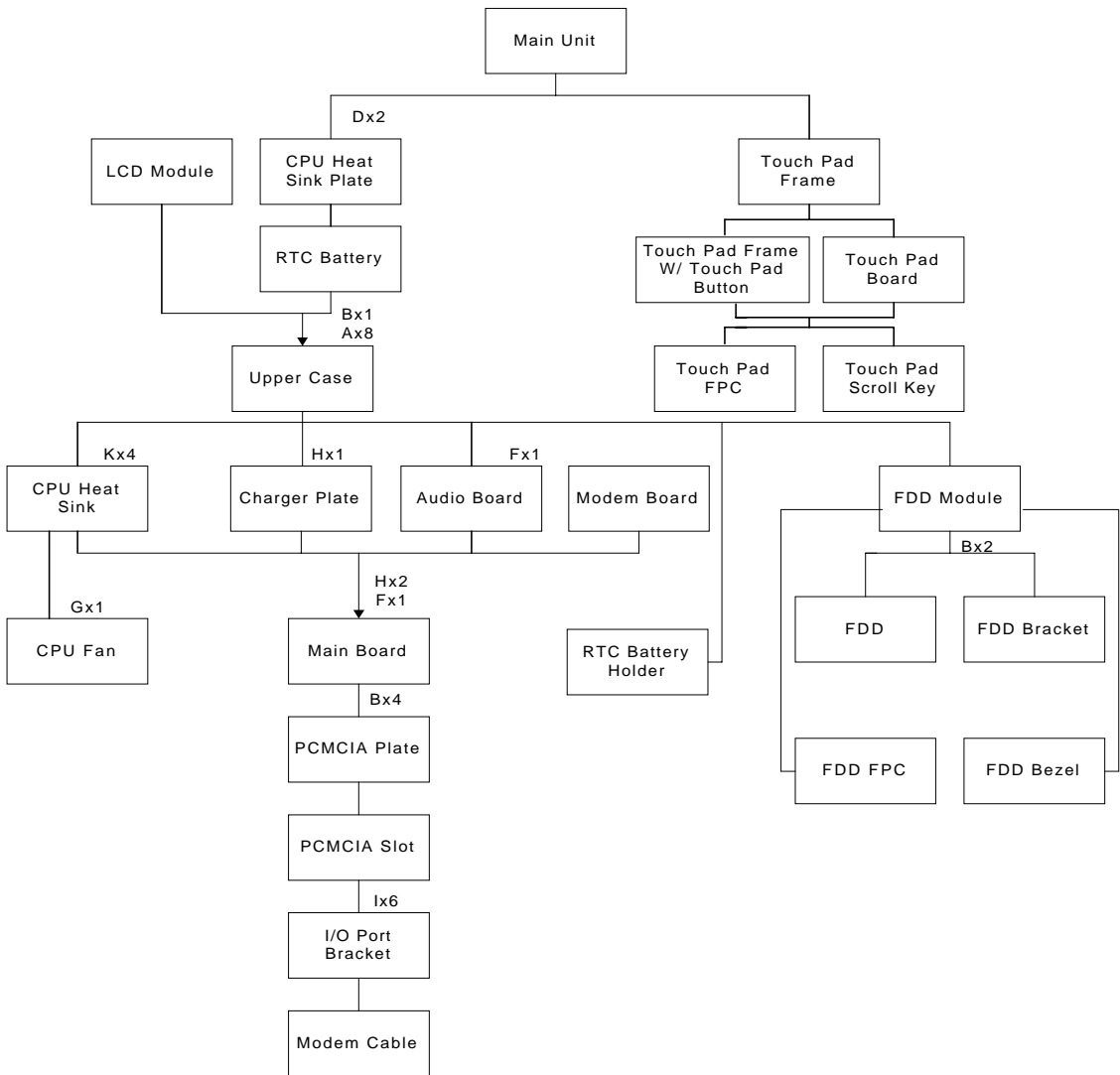

Screw List

Item	Description
A	M2.5*L6 (Black)
B	M2*L4 (Black)
C	M3*L4 (Silver)
D	M2*L10 (Black)
E	2M*L3 (Silver)
F	M2.0*L4 (Black)
G	M2.5*L4 (Silver)
H	M2*L5 (Silver)
I	SCR. HEX NUT W / WASHER&NYLOK#4 (Silver)
J	CD-ROM SPECIAL SCREW (Silver)
K	CPU Heat Sink SPECIAL SCREW (Sky blue)

Removing the Battery Pack

1. To remove the battery pack, push the battery release button inward then slide the battery pack out from the machine.



Removing the Battery Cover

1. To remove the battery cover, press the cover side outward carefully then remove the cover.



Removing the CD-ROM Drive Module

1. See “Removing the Battery Pack” on page 49
2. To remove the CD-ROM drive module, push the release button outward.



3. Slide it out from the machine.



Disassembling the CD-ROM Drive Module

1. See “Removing the Battery Pack” on page 49
2. To disassemble the CD-ROM drive module, first remove four screws as shown.



3. Remove the CD-ROM drive module from the CD-ROM drive chassis.



-
4. Remove the two screws from the CD-ROM board then remove the CDROM board from the drive.



Removing the Hard Disk Drive Module

1. See “Removing the Battery Pack” on page 49
2. To remove the hard disk drive, first remove the hard disk drive cover screw, then remove the cover.



3. Remove the hard disk drive module out from the machine carefully.



Disassembling the Hard Disk Drive Module

1. See “Removing the Battery Pack” on page 49
2. See “Removing the Hard Disk Drive Module” on page 52
3. To disassemble the hard disk drive module, first remove the two screws from the hard disk drive bracket.

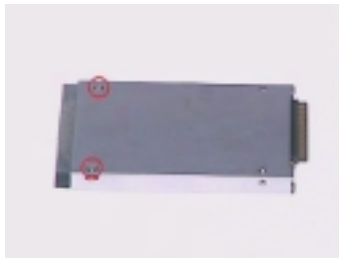

4. Remove the gasket from the hard disk drive module.



-
5. Bend both sides of the hard disk drive then remove the hard disk drive from the hard disk drive bracket.



6. Disconnect the hard disk drive connector from the hard disk drive.

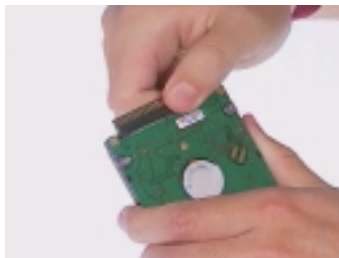

Removing the Extended Memory

1. See “Removing the Battery Pack” on page 49
2. To remove the Extended memory from the machine, first remove the screw from the memory cover.



3. Push the memory cover leftward to lift the cover off, then remove the memory cover.



4. Push out the latches on both sides of the socket and pull the memory module out from the socket.



Removing the Modem Board

1. See “Removing the Battery Pack” on page 49
2. To remove the modem board, first remove the screw from the modem cover.



3. Remove the modem cover from the machine.



4. Remove two screws from the modem board as shown, then remove the modem board from the main unit carefully by using a plastic bladed screw driver.



5. Disconnect the modem cable from the modem board, then remove the modem board.



Disassembling the LCD

Removing the Hinge Caps

1. See “Removing the Battery Pack” on page 49
2. To remove the hinge caps, push the hinge caps outward then slide the hinge caps out from the main unit.



Removing the Middle Cover

1. See “Removing the Battery Pack” on page 49
2. See “Removing the Hinge Caps” on page 56
3. To remove the middle cover, push the middle cover rightward and lift the middle cover away.



Removing the Launch Board

1. See “Removing the Battery Pack” on page 49
2. See “Removing the Hinge Caps” on page 56
3. See “Removing the Middle Cover” on page 56
4. Disconnect the launch board cable from the launch board.



-
5. Remove the two screws from the launch board then remove the launch board from the middle cover.



Removing the Cable Cover

1. See “Removing the Battery Pack” on page 49
2. See “Removing the Hinge Caps” on page 56
3. See “Removing the Middle Cover” on page 56
4. To remove the cable cover, push the cable cover backward then pull the cover off gently.



Removing the Keyboard

1. See “Removing the Battery Pack” on page 49
2. See “Removing the Hinge Caps” on page 56
3. See “Removing the Middle Cover” on page 56
4. To remove the keyboard, first pull out and upward to expose the keyboard.



-
5. Disconnect the keyboard cable from the main board carefully, then remove the keyboard from the main board.

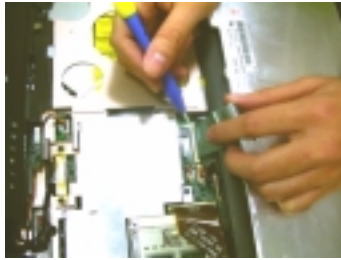

Removing the LCD Module

1. See "Removing the Battery Pack" on page 49
2. See "Removing the Hinge Caps" on page 56
3. See "Removing the Middle Cover" on page 56
4. See "Removing the Keyboard" on page 57
5. See "Removing the Cable Cover" on page 57
6. Remove the two screws from the rear of the unit and the two from the base of the unit



7. Remove the two screws from the LCD coaxial cable, and then disconnect the LCD coaxial cable from the main board.



-
8. Disconnect the inverter cable from the main board and then remove the LCD module from the main unit.



9. Disconnect the launch board cable from the main board and remove it.



Removing the Video Capture Kit Covers

1. See “Removing the Battery Pack” on page 49
2. Remove the video capture kit cover from the LCD module on each side in the way as shown here.

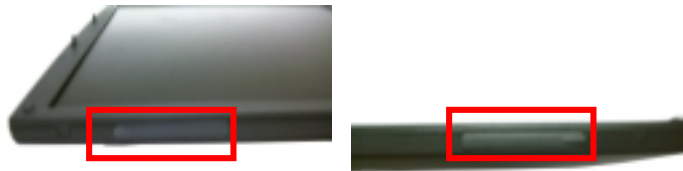

Removing the 14.1” TFT LCD Bezel

1. See “Removing the Battery Pack” on page 49
2. See “Removing the Hinge Caps” on page 56
3. See “Removing the Middle Cover” on page 56
4. See “Removing the Keyboard” on page 57
5. See “Removing the Cable Cover” on page 57
6. See “Removing the LCD Module” on page 58

-
7. Use tweezers to remove the five LCD cushions on the LCD bezel, and then remove the three screws below from the LCD bezel.



8. Snap off the bezel carefully, and then remove the LCD bezel from the LCD module.



Removing the 13.3" TFT LCD Bezel

1. See "Removing the Battery Pack" on page 49
2. See "Removing the Hinge Caps" on page 56
3. See "Removing the Middle Cover" on page 56
4. See "Removing the Keyboard" on page 57
5. See "Removing the Cable Cover" on page 57
6. See "Removing the LCD Module" on page 58
7. Remove the five LCD cushions with tweezers, and then remove the five screws from the LCD bezel.



-
8. Snap off the bezel carefully, and then remove the LCD bezel from the LCD module.



Removing the Speakers (14.1" TFT LCD)

1. See "Removing the Battery Pack" on page 49
2. See "Removing the Hinge Caps" on page 56
3. See "Removing the Middle Cover" on page 56r
4. See "Removing the Keyboard" on page 57
5. See "Removing the Cable Cover" on page 57
6. See "Removing the LCD Module" on page 58
7. See "Removing the 14.1" TFT LCD Bezel" on page 59
8. To remove the left and right speaker, first remove the two screws from the speakers.



9. To detach the speakers from the LCD panel, first disconnect the speaker cables from the left and right speaker respectively and then remove the speakers from the LCD module.



Removing the Speakers (13.3" TFT LCD)

1. See "Removing the Battery Pack" on page 49
2. See "Removing the Hinge Caps" on page 56
3. See "Removing the Middle Cover" on page 56r
4. See "Removing the Keyboard" on page 57
5. See "Removing the Cable Cover" on page 57

6. See “Removing the LCD Module” on page 58
7. See “Removing the 13.3” TFT LCD Bezel” on page 60
8. To remove the speakers, first remove the two screws from the speakers.



9. Detach the speakers from the LCD panel, disconnect the speaker cable from the speakers and then remove the speakers from the LCD module.



Removing the Inverter Board

1. See “Removing the Battery Pack” on page 49
2. See “Removing the Hinge Caps” on page 56
3. See “Removing the Middle Cover” on page 56
4. See “Removing the Keyboard” on page 57
5. See “Removing the Cable Cover” on page 57
6. See “Removing the LCD Module” on page 58
7. See “Removing the 13.3” TFT LCD Bezel” on page 60
8. To remove the inverter board, first remove two screws from the inverter board.



-
9. Disconnect the microphone cable and then remove the inverter board from the LCD panel.



10. Disconnect the LCD power cable and the inverter cable from the inverter board.



Removing the 14.1" TFT LCD

1. See "Removing the Battery Pack" on page 49
2. See "Removing the Hinge Caps" on page 56
3. See "Removing the Middle Cover" on page 56
4. See "Removing the Keyboard" on page 57
5. See "Removing the Cable Cover" on page 57
6. See "Removing the LCD Module" on page 58
7. See "Removing the 14.1" TFT LCD Bezel" on page 59
8. To remove the LCD, first remove the four screws from the LCD, then remove the LCD from the LCD panel.





Removing the 13.3" TFT LCD

1. See "Removing the Battery Pack" on page 49
2. See "Removing the Hinge Caps" on page 56
3. See "Removing the Middle Cover" on page 56
4. See "Removing the Keyboard" on page 57
5. See "Removing the Cable Cover" on page 57
6. See "Removing the LCD Module" on page 58
7. See "Removing the 13.3" TFT LCD Bezel" on page 60
8. To remove the LCD, first remove the two screws from the LCD, then remove the LCD from the LCD panel.



Removing the 13.3" TFT LCD Brackets

1. See "Removing the Battery Pack" on page 49
2. See "Removing the Hinge Caps" on page 56
3. See "Removing the Middle Cover" on page 56
4. See "Removing the Keyboard" on page 57
5. See "Removing the Cable Cover" on page 57
6. See "Removing the LCD Module" on page 58
7. See "Removing the 13.3" TFT LCD Bezel" on page 60

-
8. Remove two screws on each side to remove the LCD brackets.



Removing the LCD Coaxial Cable

1. See “Removing the Battery Pack” on page 49
2. See “Removing the Hinge Caps” on page 56
3. See “Removing the Middle Cover” on page 56
4. See “Removing the Keyboard” on page 57
5. See “Removing the Cable Cover” on page 57
6. See “Removing the LCD Module” on page 58
7. See “Removing the 14.1” TFT LCD Bezel” on page 59
8. See “Removing the 13.3” TFT LCD Bezel” on page 60
9. See “Removing the 14.1” TFT LCD” on page 63
10. See “Removing the 13.3” TFT LCD” on page 64
11. See “Removing the 13.3” TFT LCD Brackets” on page 64
12. Remove the ESD tape then remove the LCD coaxial cable from the LCD.



Removing the Microphone Cable

1. See “Removing the Battery Pack” on page 49
2. See “Removing the Hinge Caps” on page 56
3. See “Removing the Middle Cover” on page 56
4. See “Removing the Keyboard” on page 57
5. See “Removing the Cable Cover” on page 57
6. See “Removing the LCD Module” on page 58
7. See “Removing the 14.1” TFT LCD Bezel” on page 59
8. See “Removing the 13.3” TFT LCD Bezel” on page 60
9. See “Removing the 14.1” TFT LCD” on page 63
10. See “Removing the 13.3” TFT LCD” on page 64
11. Remove the ESD tape and then the microphone cable from the LCD panel.



Disassembling the Main Unit

Removing the CPU Heat Sink Plate

1. See “Removing the Battery Pack” on page 49
2. See “Removing the Hinge Caps” on page 56
3. See “Removing the Middle Cover” on page 56
4. See “Removing the Keyboard” on page 57
5. Remove two screws from the CPU heat sink plate.



6. Lift the CPU heatsink plate from the main unit.

Removing the RTC Battery

1. See “Removing the Battery Pack” on page 49
2. See “Removing the Hinge Caps” on page 56
3. See “Removing the Middle Cover” on page 56
4. See “Removing the Keyboard” on page 57
5. See “Removing the CPU Heat Sink Plate” on page 67
6. Disconnect the RTC cable and then remove the RTC battery gently.



Removing the Touch Pad Frame

1. See “Removing the Battery Pack” on page 49
2. See “Removing the Hinge Caps” on page 56
3. See “Removing the Middle Cover” on page 56
4. See “Removing the Keyboard” on page 57
5. First, disconnect the touch pad cable from the main board.



6. Detach the touch pad frame together with the touch pad button from the upper case carefully.



7. Remove the touch pad scroll key from the upper case.



8. To detach the touch pad board, first disconnect the touch pad cable from the touch pad board and then remove the touch pad board from the upper case.



Removing the Touch Pad Cable

1. See "Removing the Battery Pack" on page 49
2. See "Removing the Hinge Caps" on page 56
3. See "Removing the Middle Cover" on page 56
4. See "Removing the Keyboard" on page 57
5. See "Removing the Touch Pad Frame" on page 67
6. Remove the touch pad cable from the upper case carefully.



Removing the Upper Case

1. See “Removing the Battery Pack” on page 49
2. See “Removing the Hinge Caps” on page 56
3. See “Removing the Middle Cover” on page 56
4. See “Removing the Keyboard” on page 57
5. See “Removing the Cable Cover” on page 57
6. See “Removing the LCD Module” on page 58
7. See “Removing the CPU Heat Sink Plate” on page 67
8. See “Removing the RTC Battery” on page 67
9. Remove the screw as shown here and disconnect the FDD cable from the main unit.

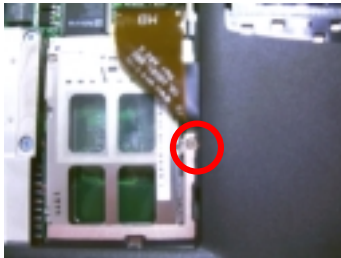

10. To remove the upper case, first remove eight screws from the base of the unit as shown.

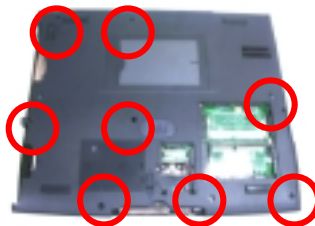

-
11. Pull the upper case from the unit gently.



Removing the RTC Battery Holder

1. See “Removing the Battery Pack” on page 49
2. See “Removing the Hinge Caps” on page 56
3. See “Removing the Middle Cover” on page 56
4. See “Removing the Keyboard” on page 57
5. See “Removing the Cable Cover” on page 57
6. See “Removing the LCD Module” on page 58
7. See “Removing the CPU Heat Sink Plate” on page 67
8. See “Removing the RTC Battery” on page 67
9. See “Removing the Upper Case” on page 69
10. Remove the RTC battery holder.



Removing the Floppy Disk Drive Module

1. See “Removing the Battery Pack” on page 49
2. See “Removing the Hinge Caps” on page 56
3. See “Removing the Middle Cover” on page 56
4. See “Removing the Keyboard” on page 57
5. See “Removing the Cable Cover” on page 57
6. See “Removing the LCD Module” on page 58
7. See “Removing the CPU Heat Sink Plate” on page 67
8. See “Removing the RTC Battery” on page 67
9. See “Removing the Upper Case” on page 69

-
10. Pull the floppy disk drive module out from the upper case carefully.



Disassembling the Floppy Disk Drive Module

1. See "Removing the Battery Pack" on page 49
2. See "Removing the Hinge Caps" on page 56
3. See "Removing the Middle Cover" on page 56
4. See "Removing the Keyboard" on page 57
5. See "Removing the Cable Cover" on page 57
6. See "Removing the LCD Module" on page 58
7. See "Removing the CPU Heat Sink Plate" on page 67
8. See "Removing the Upper Case" on page 69
9. See "Removing the Floppy Disk Drive Module" on page 70
10. Remove the two screws from the floppy disk drive bracket and remove the bracket from the drive.



11. To disassemble the floppy disk drive module, first disconnect the floppy disk drive FPC cable from the drive.



12. Detach the FDD bezel from the drive carefully.



Removing the Charger Plate

1. See “Removing the Battery Pack” on page 49
2. See “Removing the Hinge Caps” on page 56
3. See “Removing the Middle Cover” on page 56
4. See “Removing the Keyboard” on page 57
5. See “Removing the Cable Cover” on page 57
6. See “Removing the LCD Module” on page 58
7. See “Removing the CPU Heat Sink Plate” on page 67
8. See “Removing the RTC Battery” on page 67
9. See “Removing the Upper Case” on page 69
10. To remove the charger plate, first remove the screw from the charger plate then remove the charger plate from the main board.

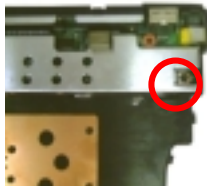

Removing the CPU Heat Sink

1. See “Removing the Battery Pack” on page 49
2. See “Removing the Hinge Caps” on page 56
3. See “Removing the Middle Cover” on page 56
4. See “Removing the Keyboard” on page 57
5. See “Removing the Cable Cover” on page 57
6. See “Removing the LCD Module” on page 58
7. See “Removing the CPU Heat Sink Plate” on page 67
8. See “Removing the RTC Battery” on page 67
9. See “Removing the Upper Case” on page 69
10. Remove the four screws to detach the CPU heatsink from the main board.



Removing the CPU Fan

1. See “Removing the Battery Pack” on page 49
2. See “Removing the Hinge Caps” on page 56
3. See “Removing the Middle Cover” on page 56
4. See “Removing the Keyboard” on page 57
5. See “Removing the Cable Cover” on page 57
6. See “Removing the LCD Module” on page 58
7. See “Removing the CPU Heat Sink Plate” on page 67
8. See “Removing the RTC Battery” on page 67
9. See “Removing the Upper Case” on page 69
10. See “Removing the CPU Heat Sink” on page 72
11. To remove the fan, first disconnect the fan cable from the main board.



12. Remove the screw from the fan, then remove the fan from the panel.



Removing the Audio Board

1. See “Removing the Battery Pack” on page 49
2. See “Removing the Hinge Caps” on page 56
3. See “Removing the Middle Cover” on page 56

4. See “Removing the Keyboard” on page 57
5. See “Removing the Cable Cover” on page 57
6. See “Removing the LCD Module” on page 58
7. See “Removing the CPU Heat Sink Plate” on page 67
8. See “Removing the RTC Battery” on page 67
9. See “Removing the Upper Case” on page 69
10. Remove the screw from the audio board and then detach the audio board.

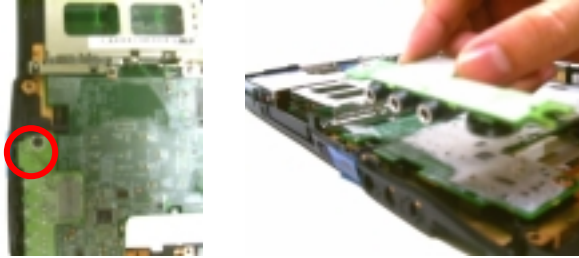

Removing the Main Board

1. See “Removing the Battery Pack” on page 49
2. See “Removing the Hinge Caps” on page 56
3. See “Removing the Middle Cover” on page 56
4. See “Removing the Keyboard” on page 57
5. See “Removing the Cable Cover” on page 57
6. See “Removing the LCD Module” on page 58
7. See “Removing the CPU Heat Sink Plate” on page 67
8. See “Removing the RTC Battery” on page 67
9. See “Removing the Upper Case” on page 69
10. See “Removing the Charger Plate” on page 72
11. See “Removing the CPU Heat Sink” on page 72
12. see “Removing the Modem Board” on page 55
13. See “Removing the Audio Board” on page 73
14. Remove the three screws from the main board as shown below.





15. Detach the main board from the lower case carefully in the way as shown here.

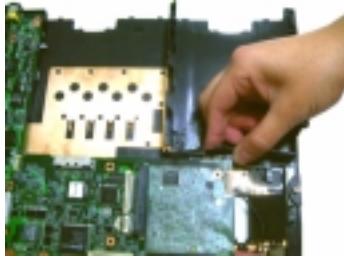

Removing the PCMCIA Slot

1. See “Removing the Battery Pack” on page 49
2. See “Removing the Hinge Caps” on page 56
3. See “Removing the Middle Cover” on page 56
4. See “Removing the Keyboard” on page 57
5. See “Removing the Cable Cover” on page 57
6. See “Removing the LCD Module” on page 58
7. See “Removing the CPU Heat Sink Plate” on page 67
8. See “Removing the RTC Battery” on page 67
9. See “Removing the Upper Case” on page 69
10. See “Removing the Charger Plate” on page 72
11. See “Removing the CPU Heat Sink” on page 72
12. See “Removing the Modem Board” on page 55
13. See “Removing the Audio Board” on page 73
14. See “Removing the Main Board” on page 74
15. Remove four screws from the PCMCIA plate to remove the plate.

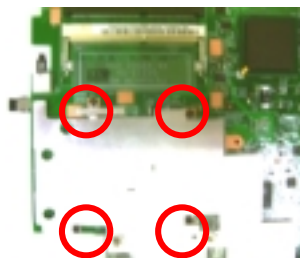

-
16. Detach the PCMCIA slot from the main board.



Removing the I/O Port Bracket

1. See "Removing the Battery Pack" on page 49
2. See "Removing the Hinge Caps" on page 56
3. See "Removing the Middle Cover" on page 56
4. See "Removing the Keyboard" on page 57
5. See "Removing the Cable Cover" on page 57
6. See "Removing the LCD Module" on page 58
7. See "Removing the CPU Heat Sink Plate" on page 67
8. See "Removing the RTC Battery" on page 67
9. See "Removing the Upper Case" on page 69
10. See "Removing the Charger Plate" on page 72
11. See "Removing the CPU Heat Sink" on page 72
12. See "Removing the Modem Board" on page 55
13. See "Removing the Audio Board" on page 73
14. See "Removing the Main Board" on page 74
15. See "Removing the PCMCIA Slot" on page 75
16. Remove the six hex screws to detach the I/O port bracket from the main board.





Removing the Modem Cable

1. See “Removing the Battery Pack” on page 49
2. See “Removing the Hinge Caps” on page 56
3. See “Removing the Middle Cover” on page 56
4. See “Removing the Keyboard” on page 57
5. See “Removing the Cable Cover” on page 57
6. See “Removing the LCD Module” on page 58
7. See “Removing the CPU Heat Sink Plate” on page 67
8. See “Removing the RTC Battery” on page 67
9. See “Removing the Upper Case” on page 69
10. See “Removing the Charger Plate” on page 72
11. See “Removing the CPU Heat Sink” on page 72
12. See “Removing the Modem Board” on page 55
13. See “Removing the Audio Board” on page 73
14. See “Removing the Main Board” on page 74
15. See “Removing the PCMCIA Slot” on page 75
16. See “Removing the I/O Port Bracket” on page 76
17. Remove the tape and disconnect the modem cable from the main board. then remove the modem cable from the main board.



Troubleshooting

Use the following procedure as a guide for computer problems.

NOTE: The diagnostic tests are intended to test only Acer products. Non-Acer products, prototype cards, or modified options can give false errors and invalid system responses.

1. Obtain the failing symptoms in as much detail as possible.
2. Verify the symptoms by attempting to re-create the failure by running the diagnostic test or by repeating the same operation.
3. Use the following table with the verified symptom to determine which page to go to.

Symptoms (Verified)	Go To
Power failure. (The power indicator does not go on or stay on.)	"Power System Check" on page 80.
POST does not complete. No beep or error codes are indicated.	"Power-On Self-Test (POST) Error Message" on page 83 "Undetermined Problems" on page 91
POST detects an error and displayed messages on screen.	"Error Message List" on page 84
The diagnostic test detected an error and displayed a FRU code.	"System Diagnostic Diskette" on page 39
Other symptoms (i.e. LCD display problems or others).	"Power-On Self-Test (POST) Error Message" on page 83
Symptoms cannot be re-created (intermittent problems).	Use the customer-reported symptoms and go to "Power-On Self-Test (POST) Error Message" on page 83 "Intermittent Problems" on page 90 "Undetermined Problems" on page 91

System Check Procedures

External Diskette Drive Check

Do the following to isolate the problem to a controller, driver, or diskette. A write-enabled, diagnostic diskette is required.

NOTE: Make sure that the diskette does not have more than one label attached to it. Multiple labels can cause damage to the drive or cause the drive to fail.

Do the following to select the test device. See “System Diagnostic Diskette” on page 39 for details.

1. Boot from the diagnostics diskette and start the PQA program (see “System Diagnostic Diskette” on page 39).
2. Go to the diagnostic Diskette Drive in the test items.
3. Press **F2** in the test items.
4. Follow the instructions in the message window.

If an error occurs with the internal diskette drive, reconnect the diskette connector on the system board.

If the error still remains:

1. Reconnect the external diskette drive/CD-ROM module.
2. Replace the external diskette drive/CD-ROM module.
3. Replace the system board.

External CD-ROM Drive Check

Do the following to isolate the problem to a controller, drive, or CD-ROM. Make sure that the CD-ROM does not have any label attached to it. The label can cause damage to the drive or can cause the drive to fail.

Do the following to select the test device:

1. Boot from the diagnostics diskette and start the PQA program (refer to “System Diagnostic Diskette” on page 39).
2. Go to the diagnostic CD-ROM in the test items.
3. Press **F2** in the test items.
4. Follow the instructions in the message window.

If an error occurs, reconnect the connector on the System board. If the error still remains:

1. Reconnect the external diskette drive/CD-ROM module.
2. Replace the external diskette drive/CD-ROM module.
3. Replace the system board.

Keyboard or Auxiliary Input Device Check

Remove the external keyboard if the internal keyboard is to be tested.

If the internal keyboard does not work or an unexpected character appears, make sure that the flexible cable extending from the keyboard is correctly seated in the connector on the system board.

If the keyboard cable connection is correct, run the Keyboard Test. See “System Diagnostic Diskette” on page 39 for details.

If the tests detect a keyboard problem, do the following one at a time to correct the problem. Do not replace a non-defective FRU:

1. Reconnect the keyboard cables.
2. Replace the keyboard.
3. Replace the system board.

The following auxiliary input devices are supported by this computer:

- Numeric keypad
- External keyboard

If any of these devices do not work, reconnect the cable connector and repeat the failing operation.

Memory Check

Memory errors might stop system operations, show error messages on the screen, or hang the system.

1. Boot from the diagnostics diskette and start the PQA program (please refer to “System Diagnostic Diskette” on page 39).
2. Go to the diagnostic memory in the test items.
3. Press **F2** in the test items.
4. Follow the instructions in the message window.

NOTE: Make sure that the DIMM is fully installed into the connector. A loose connection can cause an error.

Power System Check

To verify the symptom of the problem, power on the computer using each of the following power sources:

1. Remove the battery pack.
2. Connect the power adapter and check that power is supplied.
3. Disconnect the power adapter and install the charged battery pack; then check that power is supplied by the battery pack.

If you suspect a power problem, see the appropriate power supply check in the following list:

- “Check the Power Adapter” on page 81
- “Check the Battery Pack” on page 82

Check the Power Adapter

Unplug the power adapter cable from the computer and measure the output voltage at the plug of the power adapter cable. See the following figure

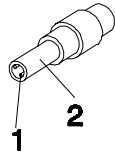

Pin 1: +19 to +20.5V
Pin 2: 0V, Ground

1. If the voltage is not correct, replace the power adapter.
2. If the voltage is within the range, do the following:
 - Replace the System board.
 - If the problem is not corrected, see “Undetermined Problems” on page 91.
 - If the voltage is not correct, go to the next step.

NOTE: An audible noise from the power adapter does not always indicate a defect.

3. If the power-on indicator does not light up, check the power cord of the power adapter for correct continuity and installation.
4. If the operational charge does not work, see “Check the Battery Pack” on page 82.

Check the Battery Pack

To check the battery pack, do the following:

From Software:

1. Check out the Power Management in control Panel
2. In Power Meter, confirm that if the parameters shown in the screen for Current Power Source and Total Battery Power Remaining are correct.
3. Repeat the steps 1 and 2, for both battery and adapter.
4. This helps you identify first the problem is on recharging or discharging.

From Hardware:

1. Power off the computer.
2. Remove the battery pack and measure the voltage between battery terminals 1(+) and 6(ground). See the following figure

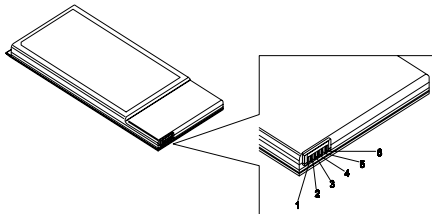

3. If the voltage is still less than 7.5 Vdc after recharging, replace the battery.

To check the battery charge operation, use a discharged battery pack or a battery pack that has less than 50% of the total power remaining when installed in the computer.

If the battery status indicator does not light up, remove the battery pack and let it return to room temperature. Re-install the battery pack.

If the charge indicator still does not light up, replace the battery pack. If the charge indicator still does not light up, replace the DC/DC charger board.

Touchpad Check

If the touchpad doesn't work, do the following actions one at a time to correct the problem. Do not replace a non-defective FRU:

1. Reconnect the touchpad cables.
2. Replace the touchpad.
3. Replace the system board.

After you use the touchpad, the pointer drifts on the screen for a short time. This self-acting pointer movement can occur when a slight, steady pressure is applied to the touchpad pointer. This symptom is not a hardware problem. No service actions are necessary if the pointer movement stops in a short period of time.

Power-On Self-Test (POST) Error Message

The POST error message index lists the error message and their possible causes. The most likely cause is listed first.

NOTE: Perform the FRU replacement or actions in the sequence shown in FRU/Action column, if the FRU replacement does not solve the problem, put the original part back in the computer. Do not replace a non-defective FRU.

This index can also help you determine the next possible FRU to be replaced when servicing a computer.

If the symptom is not listed, see “Undetermined Problems” on page 91.

The following lists the error messages that the BIOS displays on the screen and the error symptoms classified by function.

NOTE: Most of the error messages occur during POST. Some of them display information about a hardware device, e.g., the amount of memory installed. Others may indicate a problem with a device, such as the way it has been configured.

NOTE: If the system fails after you make changes in the BIOS Setup Utility menus, reset the computer, enter Setup and install Setup defaults or correct the error.

Index of Error Messages

Error Code List

Error Codes	Error Messages
006	Equipment Configuration Error Causes: 1. CPU BIOS Update Code Mismatch 2. IDE Primary Channel Master Drive Error 3. IDE Secondary Channel Master Drive Error (The causes will be shown before "Equipment Configuration Error")
010	Memory Error at xxxx:xxxx:xxxxh (R:xxxxh, W:xxxxh)
070	Real Time Clock Error
071	CMOS Battery Bad
072	CMOS Checksum Error
110	Incorrect password specified, system disabled. (Text mode only)
<No error code>	Battery critical LOW In this situation BIOS will issue 4 short beeps then shut down system, no message will show.
<No error code>	Thermal critical High In this situation BIOS will issue 3 long beeps then shut down system.

Error Message List

Error Messages	FRU/Action in Sequence
Failure Fixed Disk	Reconnect hard disk drive connector. "Load Default Settings" in BIOS Setup Utility. Hard disk drive System board
Stuck Key	see "Keyboard or Auxiliary Input Device Check" on page 80.
Keyboard error	see "Keyboard or Auxiliary Input Device Check" on page 80.
Keyboard Controller Failed	see "Keyboard or Auxiliary Input Device Check" on page 80.
Keyboard locked - Unlock key switch	Unlock external keyboard
Monitor type does not match CMOS - Run Setup	Run "Load Default Settings" in BIOS Setup Utility.
Shadow RAM Failed at offset: nnnn	BIOS ROM System board
System RAM Failed at offset: nnnn	DIMM System board
Extended RAM Failed at offset: nnnn	DIMM System board
System battery is dead - Replace and run Setup	Replace RTC battery and Run BIOS Setup Utility to reconfigure system time, then reboot system.
System CMOS checksum bad - Default configuration used	RTC battery Run BIOS Setup Utility to reconfigure system time, then reboot system.
System timer error	RTC battery Run BIOS Setup Utility to reconfigure system time, then reboot system. System board

Error Message List

Error Messages	FRU/Action in Sequence
Real time clock error	RTC battery Run BIOS Setup Utility to reconfigure system time, then reboot system. System board
Previous boot incomplete - Default configuration used	Run "Load Default Settings" in BIOS Setup Utility. RTC battery System board
Memory size found by POST differed from CMOS	Run "Load Default Settings" in BIOS Setup Utility. DIMM System board
Diskette drive A error	Check the drive is defined with the proper diskette type in BIOS Setup Utility See "External Diskette Drive Check" on page 79.
Incorrect Drive A type - run SETUP	Check the drive is defined with the proper diskette type in BIOS Setup Utility See "External Diskette Drive Check" on page 79.
System cache error - Cache disable	System board
CPU ID:	System board
DMA Test Failed	DIMM System board
Software NMI Failed	DIMM System board
Fail-Safe Timer NMI Failed	DIMM System board
Device Address Conflict	Run "Load Default Settings" in BIOS Setup Utility. RTC battery System board
Allocation Error for device	Run "Load Default Settings" in BIOS Setup Utility. RTC battery System board
Failing Bits: nnn	DIMM BIOS ROM System board
Fixed Disk n	None
Invalid System Configuration Data	BIOS ROM System board
I/O device IRQ conflict	Run "Load Default Settings" in BIOS Setup Utility. RTC battery System board
Operating system not found	Enter Setup and see if fixed disk and drive A: are properly identified. Diskette drive Hard disk drive System board

Error Message List

No beep Error Messages	FRU/Action in Sequence
No beep, power-on indicator turns off and LCD is blank.	Power source (battery pack and power adapter). See "Power System Check" on page 80. Ensure every connector is connected tightly and correctly. Reconnect the DIMM. LED board. System board.
No beep, power-on indicator turns on and LCD is blank.	Power source (battery pack and power adapter). See "Power System Check" on page 80. Reconnect the LCD connector Hard disk drive LCD inverter I LCD cabl LCD Inverter LCD System board
No beep, power-on indicator turns on and LCD is blank. But you can see POST on an external CRT.	Reconnect the LCD connectors. LCD inverter I LCD cabl LCD inverter LCD System board
No beep, power-on indicator turns on and a blinking cursor shown on LCD during POST.	Ensure every connector is connected tightly and correctly. System board
No beep during POST but system runs correctly.	Speake System board

Error Beep List

Code	Beeps	Description
00h	Two long beeps, one short beep, then one long beep.	Success
F1h	One long and one short beeps.	BIOS file size mismatch
F2h	One long and two short beeps	BIOS reading error
D1h	Two short beeps.	Floppy drive not installed

Index of Symptom-to-FRU Error Message

LCD-Related Symptoms

Symptom / Error	Action in Sequenc
LCD backlight doesn't work LCD is too dark LCD brightness cannot be adjusted LCD contrast cannot be adjusted	Enter BIOS Utility to execute "Load Setup Default Settings", then reboot system. Reconnect the LCD connectors. Keyboard (if contrast and brightness function key doesn't work). LCD inverter I LCD cabl LCD inverter LCD System board
Unreadable LCD screen Missing pels in characters Abnormal screen Wrong color displayed	Reconnect the LCD connector LCD inverter I LCD cabl LCD inverter LCD System board
LCD has extra horizontal or vertical lines displayed.	LCD inverter I LCD inverter LCD cabl LCD System board

Indicator-Related Symptoms

Symptom / Error	Action in Sequenc
Indicator incorrectly remains off or on, but system runs correctly	Reconnect the inverter board Inverter board System board

Power-Related Symptoms

Symptom / Error	Action in Sequenc
Power shuts down during operation	Power source (battery pack and power adapter). See "Power System Check" on page 80. Battery pack Power adapter Hard drive & battery connection board System board
The system doesn't power-on.	Power source (battery pack and power adapter). See "Power System Check" on page 80. Battery pack Power adapter Hard drive & battery connection board System board
The system doesn't power-off.	Power source (battery pack and power adapter). See "Power System Check" on page 80. Hold and press the power switch for more than 4 seconds. System board
Battery can't be charged	See "Check the Battery Pack" on page 82. Battery pack System board

PCMCIA-Related Symptoms

Symptom / Error	Action in Sequenc
System cannot detect the PC Card (PCMCIA)	PCMCIA slot assembly System board
PCMCIA slot pin is damaged.	PCMCIA slot assembly

Memory-Related Symptoms

Symptom / Error	Action in Sequenc
Memory count (size) appears different from actual size.	Enter BIOS Setup Utility to execute "Load Default Settings, then reboot system. DIMM System board

Speaker-Related Symptoms

Symptom / Error	Action in Sequenc
In Windows, multimedia programs, no sound comes from the computer.	Audio driver Speake System board
Internal speakers make noise or emit no sound.	Speake System board

Power Management-Related Symptoms

Symptom / Error	Action in Sequenc
The system will not enter hibernation	Keyboard (if control is from the keyboard) Hard disk drive System board
The system doesn't enter hibernation mode and four short beeps every minute.	See "Hibernation Mode" on page 26. Press Fn+ F4 and see if the computer enters hibernation mode. Touchpad Keyboard Hard disk connection board Hard disk drive System board
The system doesn't enter standby mode after closing the LCD	See "Hibernation Mode" on page 26. LCD cover switch System board
The system doesn't resume from hibernation mode.	See "Hibernation Mode" on page 26. Hard disk connection board Hard disk drive System board
The system doesn't resume from standby mode after opening the LCD.	See "Display Standby Mode" on page 26. LCD cover switch System board
Battery fuel gauge in Windows doesn't go higher than 90%.	Remove battery pack and let it cool for 2 hours. Refresh battery (continue use battery until power off, then charge battery). Battery pack System board

Power Management-Related Symptoms

Symptom / Error	Action in Sequenc
System hangs intermittently.	See "Thermal & Fan Utility" on page 39. Reconnect hard disk/CD-ROM drives. Hard disk connection board System board

Peripheral-Related Symptoms

Symptom / Error	Action in Sequenc
System configuration does not match the installed devices.	Enter BIOS Setup Utility to execute "Load Default Settings", then reboot system. Reconnect hard disk/CD-ROM/diskette drives.
External display does not work correctly.	Press Fn+F5, LCD/CRT/Both display switching See "System Diagnostic Diskette" on page 39. System board
USB does not work correctly	See "System Diagnostic Diskette" on page 39 System board
Print problems.	Ensure the "Parallel Port" in the "Onboard Devices Configuration" of BIOS Setup Utility is set to Enabled. Onboard Devices Configuration Run printer self-test. Printer driver Printer cabl Printer System Board
Serial or parallel port device problems.	Ensure the "Serial Port" in the Devices Configuration" of BIOS Setup Utility is set to Enabled. Device driver Device cable Device System board

Keyboard/Touchpad-Related Symptoms

Symptom / Error	Action in Sequenc
Keyboard (one or more keys) does not work.	Reconnect the keyboard cable. Keyboard System board
Touchpad does not work.	Reconnect touchpad cable. Touchpad board System board

Modem-Related Symptoms

Symptom / Error	Action in Sequenc
Internal modem does not work correctly.	See "System Diagnostic Diskette" on page 39. Modem phone port modem combo board System board

NOTE: If you cannot find a symptom or an error in this list and the problem remains, see "Undetermined Problems" on page 91.

Intermittent Problems

Intermittent system hang problems can be caused by a variety of reasons that have nothing to do with a hardware defect, such as: cosmic radiation, electrostatic discharge, or software errors. FRU replacement should be considered only when a recurring problem exists.

When analyzing an intermittent problem, do the following:

1. Run the advanced diagnostic test for the system board in loop mode at least 10 times.
2. If no error is detected, do not replace any FRU.
3. If any error is detected, replace the FRU. Rerun the test to verify that there are no more errors.

Undetermined Problems

The diagnostic problems does not identify which adapter or device failed, which installed devices are incorrect, whether a short circuit is suspected, or whether the system is inoperative.

Follow these procedures to isolate the failing FRU (do not isolate non-defective FRU).

NOTE: Verify that all attached devices are supported by the computer.

NOTE: Verify that the power supply being used at the time of the failure is operating correctly. (See "Power System Check" on page 80):

1. Power-off the computer.
2. Visually check them for damage. If any problems are found, replace the FRU.
3. Remove or disconnect all of the following devices:
 - Non-Acer devices
 - Printer, mouse, and other external devices
 - Battery pack
 - Hard disk drive
 - DIMM
 - CD-ROM/Diskette drive Module
 - PC Cards
4. Power-on the computer.
5. Determine if the problem has changed.
6. If the problem does not recur, reconnect the removed devices one at a time until you find the failing FRU.
7. If the problem remains, replace the following FRU one at a time. Do not replace a non-defective FRU:
 - System board
 - LCD assembly

Index of AFlash BIOS Error Message

Error Message	Action in Sequence
Hardware Error	See "System Diagnostic Diskette" on page 39
VPD Checksum Error	Reboot the system and then retest with this diskette.
BIOS Update Program Error	Turn off the power and restart the system.
System Error	Make sure this AFlash BIOS diskette for this model.
Without AC adapter	make sure to connect AC adapter
Battery Low	make sure to install a highly charged battery, and reboot system.

Index of PQA Diagnostic Error Code, Message

Error Code	Message	Action in Sequence
16XXX	Backup battery error	Backup battery
01XXX	CPU or main board error	Reload BIOS default setting. System board
02XXX	Memory error	DIM System board
03XXX	Keyboard error	Reset Keyboard Keyboard System board
04XXX	Video error	System board
05XXX	Parallel Port erro	System board
06XXX	Serial port or main board error	System board
07XXX	Diskette drive error	Diskette drive System board
08XXX	Hard disk error	Reload BIOS default setting Hard disk System board
09XXX	CD-ROM erro	Reset CD-ROM cable CD-ROM drive System board
10XXX	Co-processor erro	System board
11XXX	Pointing device erro	Reset Keyboard Keyboard System board
12XXX	Cache test error	System board

Jumper and Connector Locations

Top View

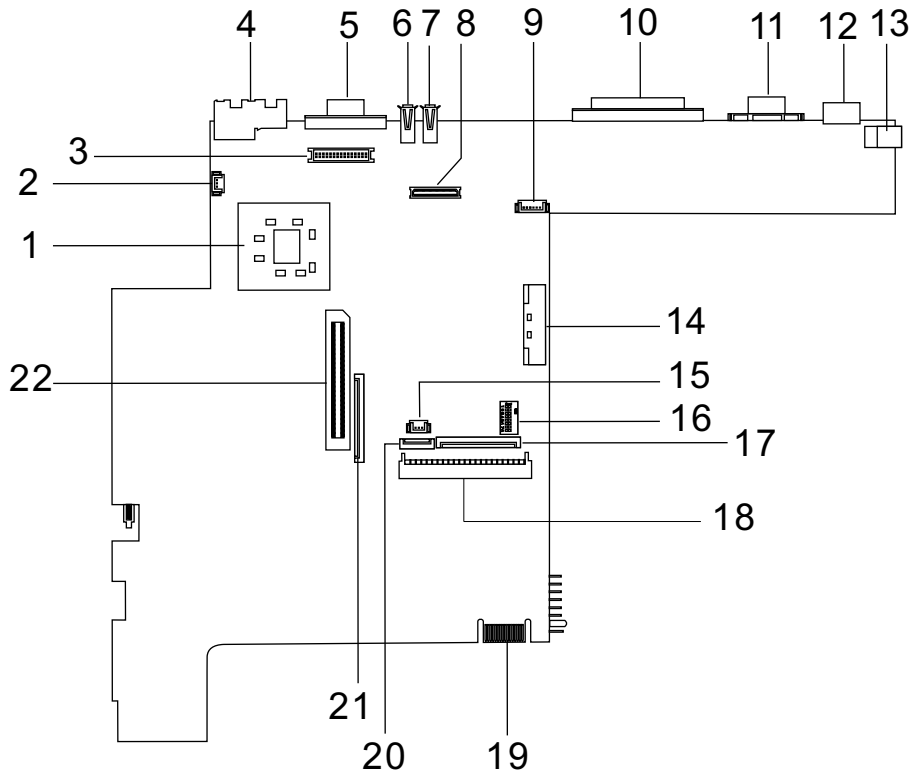

PCB No. 01213-1

1	CPU (on board)	12	PS/2 Port
2	Fan Connector	13	DC-in Port
3	Inverter Connector	14	CD-ROM Connecto
4	RJ45 + RJ11	15	RTC Battery Connector
5	External Display Port	16	Switch
6	USB Port 0	17	Internal Keyboard Cable Connector
7	USB Port 1	18	HDD Connector
8	LCD Connecto	19	Golden Finger
9	Hot Key Connector	20	Touchpad Cable Connector
10	Parallel Port	21	FDD Connecto
11	Serial Port	22	CardBus Connector

Keyboard Switch Settings

	SW1-1	SW1-2
English	OFF	OFF
Japanese	ON	OFF
Europe	OFF	ON

SW-4/5

	SW1-4	SW1-5
Acer	OFF	OFF
OEM1	ON	OFF
OEM2	OFF	ON
OEM3	ON	ON

SW1-6: Check Password

SW1-6 = ON, Disable

SW1-6 = OFF, Enable

SW1-7: Boot Block Boot

SW1-7 = OFF, Enable

SW1-7 = On, Disable

Bottom View

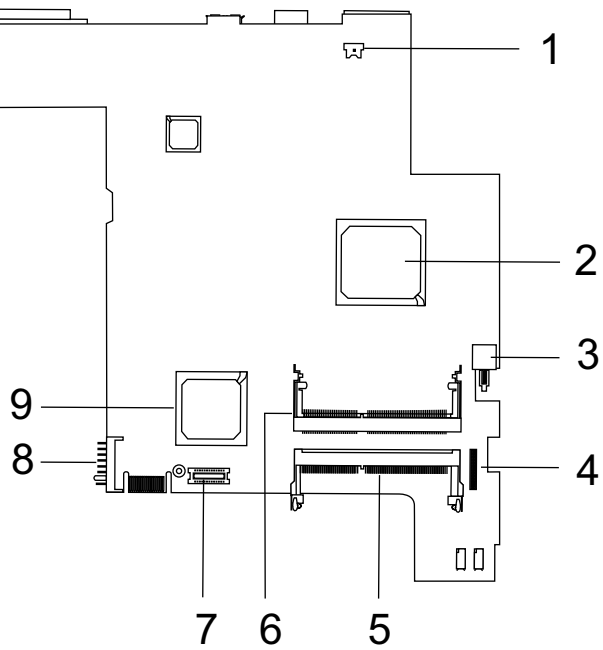





- | | | | |
|---|------------------------|---|----------------------------|
| 1 | Modem Connector | 6 | DIMM 1 Socket |
| 2 | North Bridge (82830MG) | 7 | Modem Card Cable Connector |
| 3 | Power Switch | 8 | Battery Connector |
| 4 | Audio Board Connector | 9 | South Bridge (ICH3-M) |
| 5 | DIMM 2 Socket | | |





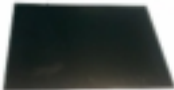

FRU (Field Replaceable Unit) List







This chapter gives you the FRU (Field Replaceable Unit) listing in global configurations of TravelMate 220/260. Refer to this chapter whenever ordering for parts to repair or for RMA (Return Merchandise Authorization).

Please note that WHEN ORDERING FRU PARTS, you should check the most up-to-date information available on your regional web or channel. For whatever reasons a part number change is made, it will not be noted on the printed Service Guide. For ACER AUTHORIZED SERVICE PROVIDERS, your Acer office may have a DIFFERENT part number code from those given in the FRU list of this printed Service Guide. You MUST use the local FRU list provided by your regional Acer office to order FRU parts for repair and service of customer machines.



NOTE: To scrap or to return the defective parts, you should follow the local government ordinance or regulations on how to dispose it properly, or follow the rules set by your regional Acer office on how to return it.







Picture	No.	Partname	Description
Memory			
	NS	MEMORY SDIMM 256	SODIMM 256M HYS64V32220GDL-7.5
LCD			
	05	LCD 14.1" XGA	LCD 14.1" XGA AU/B141XN04/3
Cable			
	NS	CABLE ASSY MODEM FALCON2	CABLE ASSY MODEM FALCON
	NS	C.A. LAUNCH FALCON2	C.A. LAUNCH FALCON2
	NS	CABLE ASSY MICRO (13.3" & 12.1") FL	CABLE ASSY MICRO (13.3" & 12.1") FL
	NS	CABLE ASSY LED & INV (14.1") FL2	CABLE ASSY LED & INV (14.1") FL2



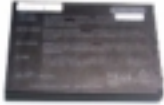



Picture	No.	Partname	Description
	NS	CORD 125V UL 3P K01081183WP	CORD 125V UL 3P K01081183WP
	NS	CABLE ASSY FDD FPC FALCON2	CABLE ASSY FDD FPC FALCON2
Case/Cover/Bracket Assembly			
	NS	ASSEMBLY LOWER CASE FALCON3M	ASSEMBLY LOWER CASE FALCON3M
	10	ASSY LCD PANEL 14.1" PNL	ASSY LCD PANEL 14.1" ADT
	08	ASSY LCD BEZEL 14.1' BZL	ASSY LCD BEZEL 14.1' ADT
	12	ASSEMBLY UPPER CASE	ASSEMBLY UPPER CASE F3
	NS	ASSEMBLY MIDDLE COVER	ASSEMBLY MIDDLE COVER F3





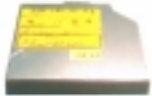

Picture	No.	Partname	Description
	09	ASSEMBLY HDD DOOR	ASSEMBLY HDD COVER F3M
	15	ASSEMBLY MODEM COVER F3M	ASSEMBLY MODEM COVER F3M
	14	ASSEMBLY DIMM COVER F3M	ASSEMBLY DIMM COVER F3M
	NS	ASSEMBLY CHARGER PLATE F3M	ASSEMBLY CHARGER PLATE F3M
	03	BRACKET FDD REAR F3M	BRACKET FDD REAR F3M
	17	ASSY FDD BEZEL BZL	ASSY FDD BEZEL PANASONIC F3M

Picture	No.	Partname	Description
	NS	ASSEMBLY CD/DVD CHASSIS F3M	ASSEMBLY CD/DVD CHASSIS F3
	NS	HDD ASSY(9.5MM) BRACKET FALCON2	HDD ASSY(9.5MM) BRACKET FALCON2
	07	CAP HINGE L HIGH F3	CAP HINGE L HIGH F3
	06	CAP HINGE R HIGH F3	CAP HINGE R HIGH F3M
	NS	COVER CABLE F3M	COVER CABLE F3M
	04	BATTERY COVER F3	DOOR BATTERY F3M

Picture	No.	Partname	Description
	NS	RTC BATTERY HOLDER F3M	HOLDER RTC BATTERY F3M
Board			
	NS	INVERTER Ambit T62.172.00 V.60 FAL	INVERTER T621172.00REV.60 FAL
	NS	MODEM BOARD AMBIT/ T60M283..00	MODEM MDC AMBIT/T60M283..00 3A
	NS	LAUNCH BOARD	FALCON2 LAUNCH BOARD
	NS	TM210 AUDIO BOARD F2	TM210 AUDIO BOARD F2
	NS	FALCON 3M CD-ROM BD	FALCON 3M CD-ROM BD
Battery			
	NS	RTC BTY LI 3V	BTY LI 3V CR2032T6 210MAH 50MM

Picture	No.	Partname	Description
	NS	BTY PACK LI+/PANASONIC	BTY PACK LI+ 2AH 8CELL PANA
Adapter			
	NS	ADT 60W ADP-60DHBN 3P	ADT 60W ADP-60DHBN 3P
Keyboard			
	NS	KEYBOARD	KB US NSK-84X21
	NS	KEYBOARD	KB US/INTERNATIONAL NSK-84X22
	NS	KEYBOARD	KEYBOARD CHINESE NSK-84X2C
Speaker			
	09	SPEAKER-R (14.1") FL2.5	SPEAKER-R (14.1") FL2.5
	09	SPEAKER-L (14.1") FL2.5	SPEAKER-L (14.1") FL2.5
Heatsink			
	02	HEATSINK CPU F3M	HEATSINK CPU F3M

Picture	No.	Partname	Description
FDD/Floppy Disk Drive			
	29	ASSY FDD MODULE 1.44 PANASONIC F3	ASSY FDD MODULE PANASONI F3M
	NS	FDD 1.44M	FDD 1.44M MCI/JU226A253F
HDD/Hard Disk Drive			
	NS	HDD MODULE IBM 20G F3	ASSY HDD MODULE IBM 20G F3M
	NS	HDD 20G IB	HDD 20G IBM/IC25N920ATDA04
DVD-ROM DRIVE			
	NS	ASSY DVD-ROM MODULE TM220	ASSY DVDROM MODULE PIONEER F3M
	NS	DVD-ROM 8X MATSUSHITA	DVD-ROM 8X MKE/SR-8176BAA2 ME34

Picture	No.	Partname	Description
Mainboard			
	NS	MAINBOARD W/CPU CEL-933 TM220	FALCON 3M MB W/CPU CEL-933
Mainboard Components			
	NS	PCMCIA SLOT/PC CARD SLOT	CONN CARDPUSH 1 CA91501-TC-F2
	NS	CONNECTOR 22PIN	CONN CTR ML 22P HH98227 A2(HDD)
Miscellaneous			
	NS	PLATE CPU HEATSINK F3M	PLATE CPU HEATSINK F3M
	NS	PLATE PCMCIA F3M	PLATE PCMCIA F3M
	NS	LBL NAME PLATE 99.8*8.3 TM220	LBL NAME PLATE 99.8*8.3 TM220
	03	RUBBER SCREW DOWN FL2	RUBBER SCREW DOWN FL2

Picture	No.	Partname	Description
Screws			
	NS	M/B, CASE, POWER SUPPLY SCREW	SCR. HEX NUT W/WASHER&NYLOK #4
	NS	SCREW	SCREW CPU FALCON 2.5
	NS	SCREW BINDING BL-ZN M2*.4P	SCREW BINDING BL-ZN M2*.4P
	NS	SCREW BINDING BL-ZN M2*4L	SCREW BINDING BL-ZN M2*4L
	NS	SCREW M2L5 BH MSN+N	SCREW M2L5 BH MSN+
	NS	LCD SCREW	SCREW M2.5X6

Model Definition and Configuration

Model Number Definitions

Model Number	LCD	CPU	Memory	HD	CD/DV	Battery
261X	14.1" TFT	Pentium III 1G	256MB	20GB	CD-RO	Li-ion
260XC	14.1" TFT	Pentium III 1G	256MB	20GB	Combo or DVD-ROM	Li-ion
260XV	14.1" TFT	Pentium III 1G	256MB	10GB	DVD-ROM	Li-ion

Test Compatible Component

This computer's compatibility is tested and verified by Acer's internal testing department. All of its system functions are tested under Windows XP Home Edition.

Refer to the following lists for components, adapter cards, and peripherals which have passed these tests. Regarding configuration, combination and test procedures, please refer to the TravelMate 220/260 series notebook Compatibility Test Report released by the Acer Mobile System Testing Department.

Microsoft Windows XP Home Edition Environment Test

Item	Specifications
Processor	Pentium III 1G above, 256k (TravelMate 260) Celeron 1.06G, 256k (TravelMate 220)
Memory	Infineon 128MB Infineon 256MB
LCD	13.3" XGA TFT (AU) 14.1" XGA TFT (AU)
Floppy Disk Drive	MCI
Hard Disk Drive	IBM 10GB 9.5mm IBM 20GB 9.5mm
CD-ROM	Mitsumi 24X
DVD-ROM	MKE 8X
Combo Drive (DVD + CD-RW)	KME
Battery	Simplo Li-ION
AC Adapter	Delta / ADP-60DB (3pin)
SW Modem	Ambit 56K modem
Keyboard	API
Power cord	3pin
VGA Chip	Intel 830MG Built-in VGA
Audio	AC97
Touch Pad	Synaptics
Inverter	AMBIT

Online Support Information

This section describes online technical support services available to help you repair your Acer Systems.

If you are a distributor, dealer, ASP or TPM, please refer your technical queries to your local Acer branch office. Acer Branch Offices and Regional Business Units may access our website. However some information sources will require a user i.d. and password. These can be obtained directly from Acer CSD Taiwan.

Acer's Website offers you convenient and valuable support resources whenever you need them.

In the Technical Information section you can download information on all of Acer's Notebook, Desktop and Server models including:

- Service guides
- User's manuals
- Training materials
- Main manuals
- Bios updates
- Software utilities
- Spare parts lists
- Chips
- TABs (Technical Announcement Bulletin)

For these purposes, we have included an Acrobat File to facilitate the problem-free downloading of our technical material.

Also contained on this website are:

- Detailed information on Acer's International Traveller's Warranty (ITW)
- Returned material authorization procedures
- An overview of all the support services we offer, accompanied by a list of telephone, fax and email contacts for all your technical queries.

We are always looking for ways to optimize and improve our services, so if you have any suggestions or comments, please do not hesitate to communicate these to us.

A

AC Adapter 25
 AFLASH Utility 40
 Audio 17, 21

B

Battery 23
 battery pack
 charging indicator 10
 BIOS 17
 package 17
 ROM size 17
 ROM type 17
 vendor 17
 Version 17
 BIOS Setup Utility 30
 BIOS Supports protocol 17
 BIOS Utility 30–??
 Basic System Settings 33
 Load Default Settings 39
 Navigating 31
 Onboard Device Configuration 35
 Startup Configuration 33
 System Information 32
 System Security 36
 Board Layout 4
 Bottom View 5
 Top View 4
 brightness
 hotkeys 13

C

Cache
 controller 17
 size 17
 caps lock
 on indicator 10
 CardBus 23

CD-ROM Interface 20
 Chipsets 17
 computer
 on indicator 10
 contrast
 hotkeys 13
 Controllers 17
 Core logic 17
 CPU
 core voltage 17
 I/O voltage 17
 package 17
 type 17

D

DC-AC LCD Inverter 24
 DC-DC/Charger 23
 Design 2
 DIMM 18
 Combinations 18
 package 18
 Speed 18
 voltage 18
 Disassembly
 Machine 44
 Disassembly Flowchart 46
 Display 2
 display
 hotkeys 13
 Display Standby Mode 26
 DMA Channel Assignment 28
 DVD-ROM Interface 20

E

Environmental Requirements 26
 Error Symptom-to-Spare Part Index 83
 External CD-ROM Drive Check 79
 External Diskette Drive Check 79

F

- Features 1
- Flash Utility 40
- Floppy Disk Drive Interface 19
- FRU (Field Replaceable Unit) List 98

H

- Hard disk 17, 19
- Hard Disk Drive Module
 - Disassembly 52
- Hard Disk Standby Mode 26
- Hardware Specifications and Configurations 15
- HDD 17, 19
- Hibernation Mode 26
- Hibernation mode
 - hotkey 13
- Hot Keys 13

I

- I/O Address Map 27
- Indicators 10
- Intermittent Problems 90
- IRQ Assignment Map 28

J

- Jumper and Connector Locations
 - Bottom View 96
 - SW2 Settings 95
 - Top View 94, 96

K

- Keyboard 17, 23
- Keyboard or Auxiliary Input Device Check 80

L

- L2 cache 17
- LCD 24

M

- Machine Disassembly 44
- Mechanical Specification 26
- media access

on indicator 10

- Memory
 - Address Map 27
- Memory Address Map 27
- Memory Check 80
- Model Number Definitions 110
- Modem 19

N

- Notebook Manager
 - hotkey 13
- num lock
 - on indicator 10

O

- Online Support Information 114

P

- Panel 5
 - Bottom 9
 - Rear 8
 - right 8
- Parallel Port 22
- parallel port
 - setting in BIOS Utility 35
- Password Setting
 - Hard Disk Password 37
 - Power-On Password 37
 - Setup Password 37
- PC Card 10, 23
- PCMCIA 23
- Power Management 26
- Power management 2
- Power System Check 80
 - Battery Pack 82
 - Power Adapter 81
- PQA 40
- Processor 17

R

Removing the Battery Pack 49
RMA 98
RTC 17

S

Second Level Cache 17
Serial Port 22
speakers
 hotkey 13
Standby Mode 26
Super I/O 17
System
 Block Diagram 3
 Layout 4
System Check Procedures 79
System Diagnostic Diskette 40
System Memory 18
System Utilities 30
System Utility Diskette 40

T

Temperature 26
Test Compatible Components 112
Touchpad 15
touchpad
 hotkey 13
Touchpad Check 82
Troubleshooting 78

U

Undetermined Problems 91
USB 23
utility
 BIOS 30–??

V

Video 21, 22
 Resolutions 22
Video controller 17

W

Windows 98 SE/98 JP SE ACPI Environment Test
113

